

**Battente
Battant
Swinging
Bottiente**

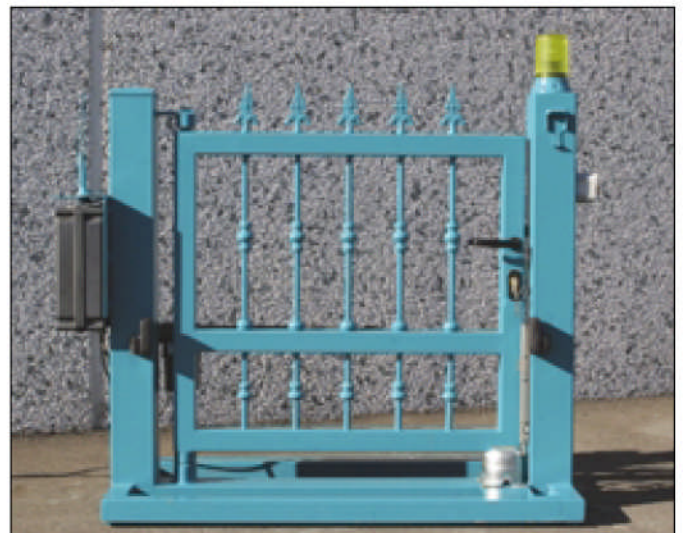

**Scorrevole
Coulissant
Sliding
Corredera**

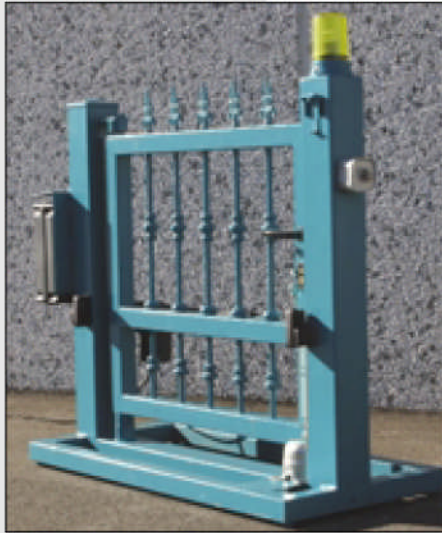
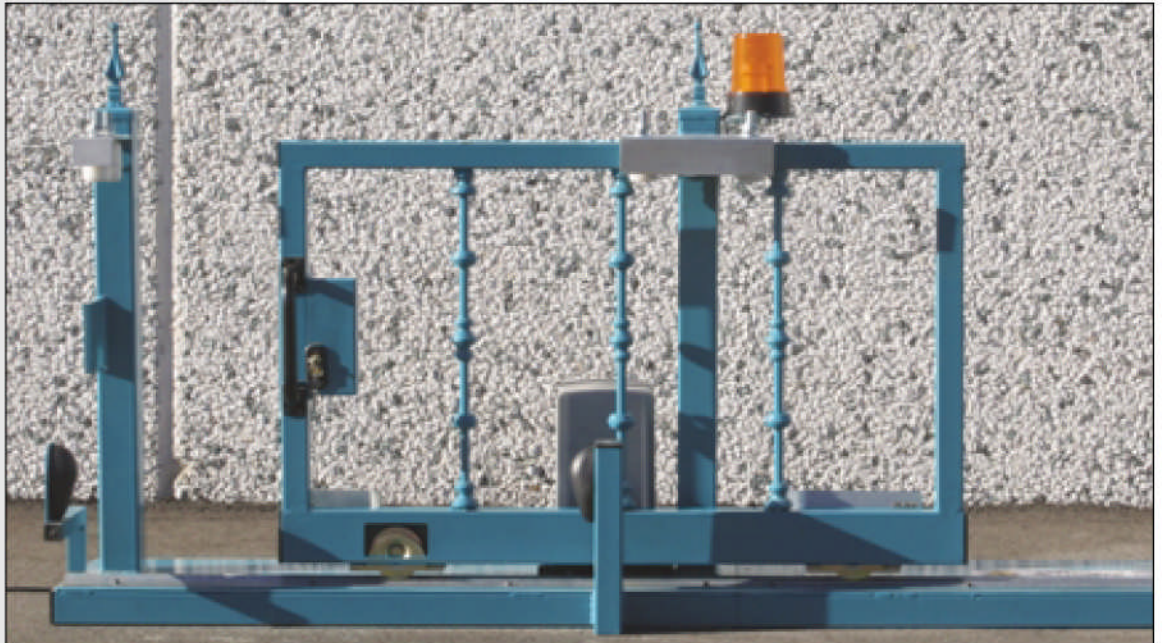

**Autoportante
Autoportant
Cantilever
Autoportante**

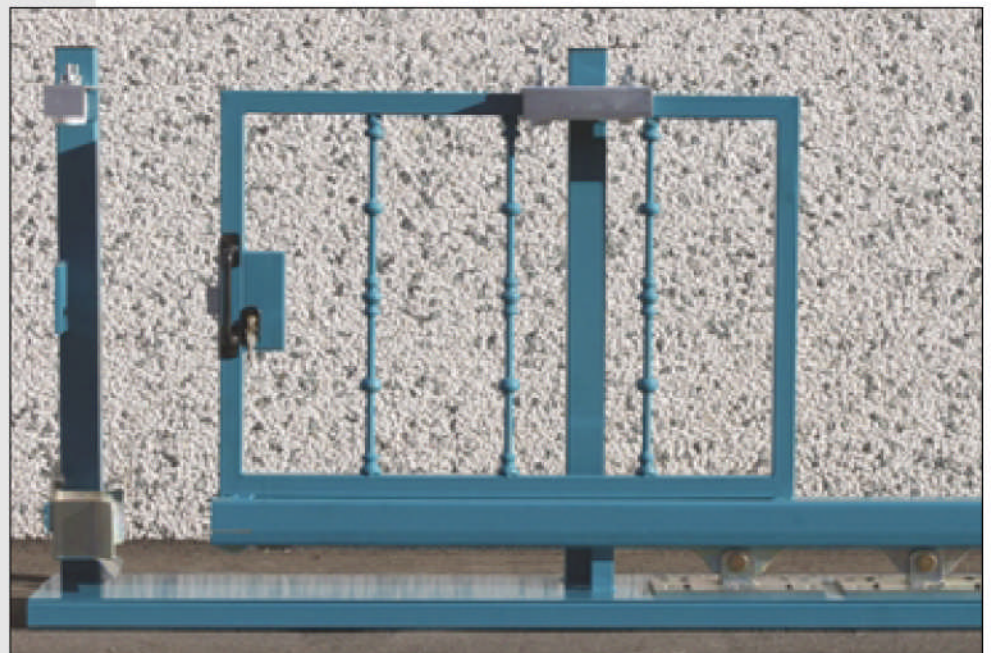

Art. 360

Ruota per cancelli - 1 cuscinetto a sfera - Gola V

Roues pour portail coulissant - 1 roulement à billes - Gorge V
 Wheels for sliding gates - 1 ball bearing - Groove V
 Poleas por cancela - 1 rodamiento de bolas - Canal V



In acciaio tropicalizzato
 En acier bichromaté
 Yellow galvanized steel
 Hierro bicromatado

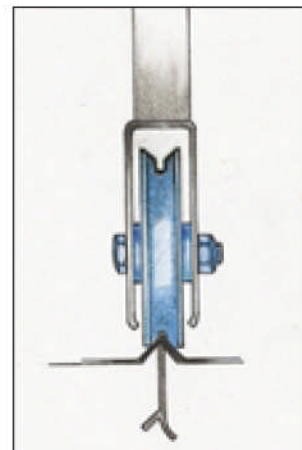
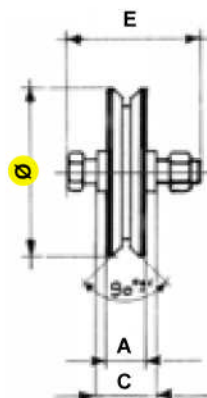

Ø mm	50	60	70	80	90	100	120	140	160
A mm	17	17	20	20	20	20	20	25	25
C mm	19	24	24	33	33	33	33	44	44
E mm	10x45	10x45	14x60	14x60	14x60	14x60	14x60	16x70	16x70
Portata 2 ruote Force 2 roues Kg. Capacity 2 wheels Capacidad 2 poleas	120	200	300	300	300	400	400	600	700
CODICE ART.	360050	360060	360070	360080	360090	360100	360120	360140	360160
N° Pcs	1	1	1	1	1	1	1	1	1
Kg.	0,200	0,370	0,650	0,750	0,950	1,100	1,700	2,800	3,700

Art. 361

Ruota per cancelli - 1 cuscinetto a sfera - Gola Tonda

Roues pour portail coulissant - 1 roulement à billes - Gorge ronde
 Wheels for sliding gates - 1 ball bearing - Round groove
 Poleas por cancela - 1 rodamiento de bolas - Canal redondo



In acciaio tropicalizzato
 En acier bichromaté
 Yellow galvanized steel
 Hierro bicromatado

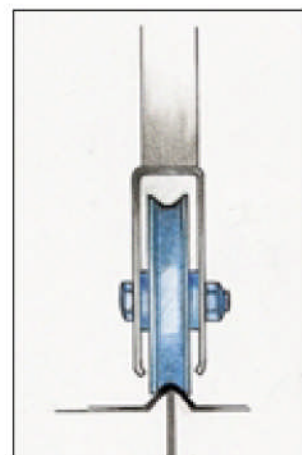
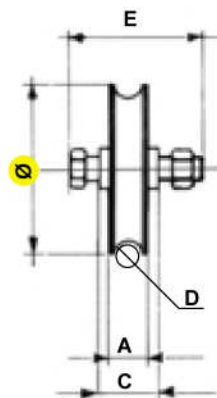

Ø mm	50	60	70	80	100	120
A mm	17	17	20	20	20	20
C mm	19	24	33	33	33	33
E mm	10x45	10x45	14x60	14x60	14x60	14x60
D mm	10	12	14	14	14	14
Portata 2 ruote Force 2 roues Kg. Capacity 2 wheels Capacidad 2 poleas	120	200	300	300	400	400
CODICE ART.	361050	361060	361070	361080	361100	361120
N° Pcs	1	1	1	1	1	1
Kg.	0,200	0,370	0,650	0,750	1,100	1,700

Art. 364

Ruota per cancelli - 1 cuscinetto a sfera - Gola Tonda Ø 20

Roues pour portail coulissant - 1 roulement à billes - Gorge ronde Ø 20
Wheels for sliding gates - 1 ball bearing - Round groove Ø 20
Poleas por cancela - 1 rodamiento de bolas - Canal redondo Ø 20

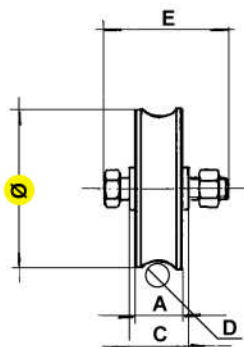

In acciaio tropicalizzato
En acier bichromaté
Yellow galvanized steel
Hierro bicromatado

Ø mm	80	100	120	140	160
A mm	25	25	25	25	25
C mm	33	33	33	43	43
E mm	14x60	14x60	14x60	16x70	16x70
D mm	20	20	20	20	20
Portata 2 ruote Force 2 roues Kg. Capacity 2 wheels Capacidad 2 poleas	300	400	400	600	700
CODICE ART.	364080	364100	364120	364140	364160
N° Pcs	1	1	1	1	1
Kg.	0,650	1,200	1,650	2,500	3,750

Art. 364/P

Ruota per cancelli - 1 cuscinetto a sfera - Gola Tonda Ø 16

Roues pour portail coulissant - 1 roulement à billes - Gorge ronde Ø 16
Wheels for sliding gates - 1 ball bearing - Round groove Ø 16
Poleas por cancela - 1 rodamiento de bolas - Canal redondo Ø 16

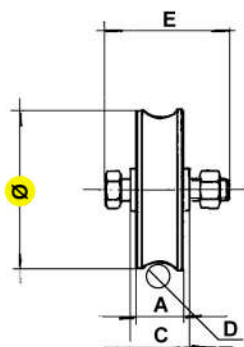

In acciaio tropicalizzato
En acier bichromaté
Yellow galvanized steel
Hierro bicromatado

Ø mm	80	100	120
A mm	22	22	22
C mm	33	33	33
E mm	14x60	14x60	14x60
D mm	16	16	16
Portata 2 ruote Force 2 roues Kg. Capacity 2 wheels Capacidad 2 poleas	300	400	400
CODICE ART.	364080P	364100P	364120P
N° Pcs	1	1	1
Kg.	0,650	1,200	1,500

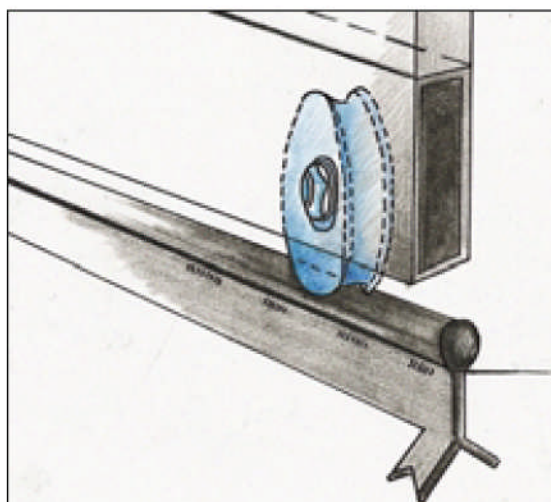

Ruota per cancelli - 2 cuscinetti a sfera - Gola V

Art. 362

Roues pour portail coulissant - 2 roulements à billes - Gorge V
Wheels for sliding gates - 2 ball bearing - Groove V
Poleas por cancela - 2 rodamientos de bolas - Canal V

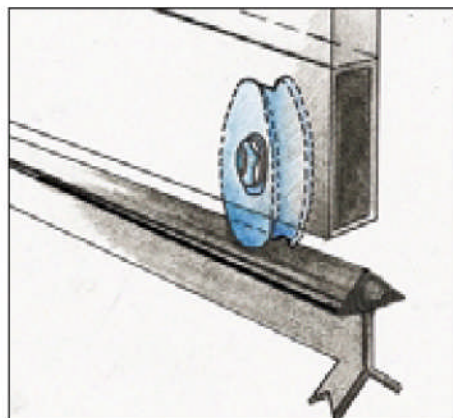
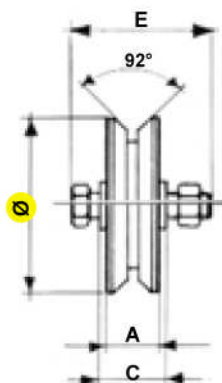

In acciaio tropicalizzato - En acier bichromaté
Yellow galvanized steel - Hierro bicromatado

Ø mm	80	90	100	160	180	200
A mm	30	30	30		32	32
C mm	34	34	34		44	44
E mm	14x70	14x70	14x70	16 x 70	16x70	16x70
Portata 2 ruote Force 2 roues Kg. Capacity 2 wheels Capacidad 2 poleas				1,200	1,300	1,300
CODICE ART.	362080	362090	362100	362160	362180	362200
N° Pcs	1	1	1	1	1	1
Kg.	1,100	1,300	1,550	4,000	5,500	7,000

Ruota per cancelli - 2 cuscinetti a sfera - Gola Tonda

Art. 363

Roues pour portail coulissant - 2 roulements à billes - Gorge ronde
Wheels for sliding gates - 2 ball bearing - Round groove
Poleas por cancela - 2 rodamientos de bolas - Canal redondo

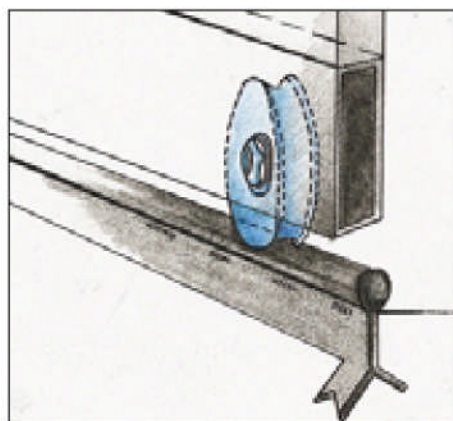
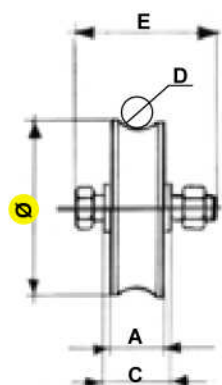

In acciaio tropicalizzato - En acier bichromaté
Yellow galvanized steel - Hierro bicromatado

Ø mm	80	90	100	120	140	160	180	200
B mm	30	30	30	30	32	32	32	32
C mm	34	34	34	34	44	44	44	44
E mm	14x70	14x70	14x70	14x70	16x70	16x70	16x70	16x70
D mm	20	20	20	20	20	20	20	20
Portata 2 ruote Force 2 roues Kg. Capacity 2 wheels Capacidad 2 poleas	500	500	700	900	1,000	1,200	1,300	1,300
CODICE ART.	363080	363090	363100	363120	363140	363160	363180	363200
N° Pcs	1	1	1	1	1	1	1	1
Kg.	1,100	1,300	1,550	2,300	3,200	4,000	5,500	7,000

Ruote con ingrassatore / Roues avec graisseur
Wheels with lubrication / Poleas con engrasador

Art. 366-367

Ruota per cancelli - 2 cuscinetti - Gola V o Tonda con ingrassatore
Roues pour portail coulissant - 2 roulements à billes - Gorge V / ronde avec graisseur
Wheels for sliding gates - 2 ball bearing - Groove V round with lubrication
Poleas por cancela - 2 rodamientos de bolas - Canal V / redondo con engrasador

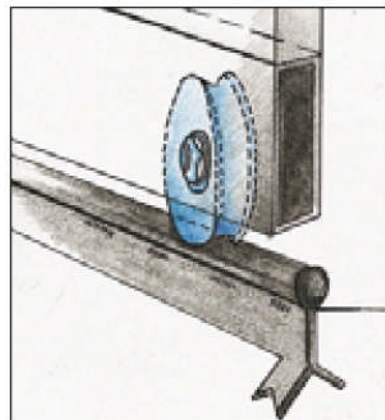
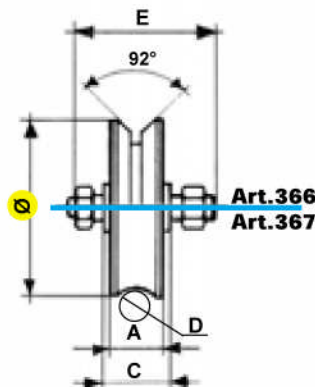

In acciaio tropicalizzato
En acier bichromaté
Yellow galvanized steel
Hierro bicromatado

Art. 366 Gola V
Gorge V
Groove V
Canal V
Art. 367 Gola tonda
Gorge ronde
Groove round
Canal redondo

Ø mm	120	140	160	200
A mm	37	37	37	37
C mm	44	44	44	44
E mm	18x90	18x90	18x90	18x90
D mm	24	24	24	24
Portata 2 ruote Force 2 roues Kg. Capacity 2 wheels Capacidad 2 poleas	900	1,000	1,200	1,300
CODICE ART. 366	366120	366140	366160	366200
CODICE ART. 367	367120	367140	367160	367200
N° Pcs	1	1	1	1
Kg.	2,650	3,500	4,750	6,500

Art. 366/S-367/S

Ruota per cancelli - 2 cuscinetti - Gola V o Tonda con ingrassatore
Roues pour portail coulissant - 2 roulements à billes - Gorge V / ronde avec graisseur
Wheels for sliding gates - 2 ball bearing - Groove V / round with lubrication
Poleas por cancela - 2 rodamientos de bolas - Canal V / redondo con engrasador

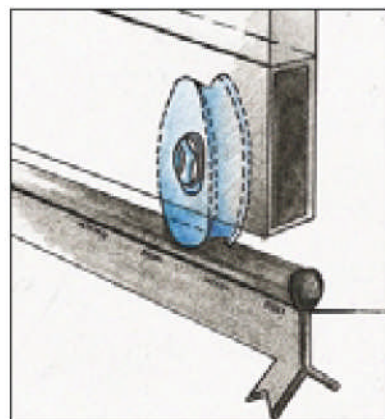
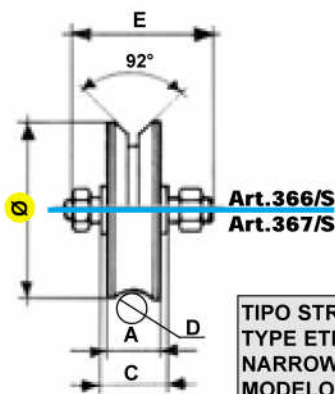

TIPO STRETTO
TYPE ETROIT
NARROW MODEL
MODELO ESTRECHO

Art. 366/S Gola V
Gorge V
Groove V
Canal V
Art. 367/S Gola tonda
Gorge ronde
Groove round
Canal redondo

Ø mm	80	100	120	140	160	180	200
A mm	30	30	30	32	32	32	32
C mm	34	34	34	44	44	44	44
E mm	14x70	14x70	14x70	16x70	16x70	16x70	16x70
D mm	20	20	20	20	20	20	20
Portata 2 ruote Force 2 roues Kg. Capacity 2 wheels Capacidad 2 poleas	500	700	900	1,000	1,200	1,300	1,300
COD. ART. 366/S	366080S	366100S	366120S	366140S	366160S	366180S	366200S
COD. ART. 367/S	367080S	367100S	367120S	367140S	367160S	367180S	367200S
N° Pcs	1	1	1	1	1	1	1
Kg.	1,100	1,550	2,300	3,200	4,000	5,500	7,000

**Ruote con supporto esterno / Roues avec support exterieur
Wheels with external support / Poleas con soporte superior**

Art. 386

Ruota con supporto esterno - 1 cuscinetto - Gola V

Roues avec support exterieur - 1 roulement à billes - Gorge V
Wheels with external support - 1 ball bearing - Groove V
Poleas con soporte superior - 1 rodamiento de bolas - Canal V

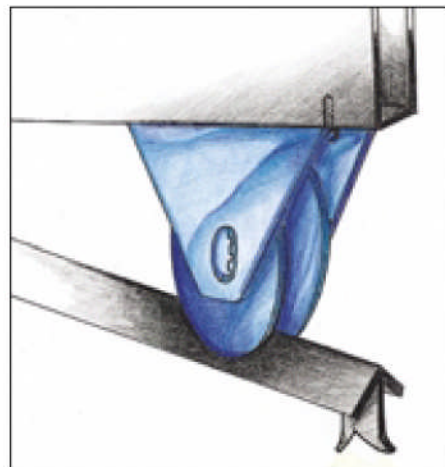
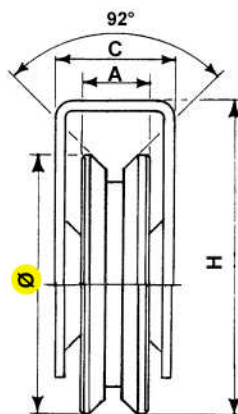

In acciaio tropicalizzato
En acier bichromaté
Yellow galvanized steel
Hierro bicromatado

Ø mm	50	60	70	80	90	100
A mm	17	17	20	20	20	20
C mm	19	24	24	33	33	33
H mm	58	63	77	95	100	105
Portata 2 ruote Force 2 roues Kg. Capacity 2 wheels Capacidad 2 poleas	120	150	200	300	300	350
CODICE ART.	386050	386060	386070	386080	386090	386100
N° Pcs	1	1	1	1	1	1
Kg.	0,450	0,550	0,750	0,900	1,100	1,300

Art. 385

Ruota con supporto esterno - 1 cuscinetto - Gola Tonda

Roues avec support exterieur - 1 roulement à billes - Gorge ronde
Wheels with external support - 1 ball bearing - Round groove
Poleas con soporte superior - 1 rodamiento de bolas - Canal redondo

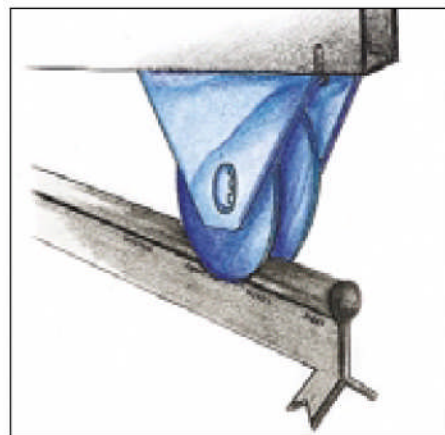
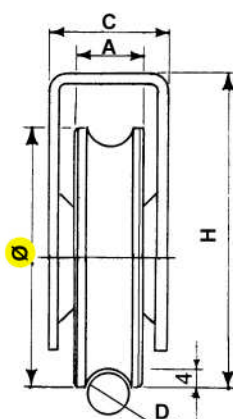

In acciaio tropicalizzato
En acier bichromaté
Yellow galvanized steel
Hierro bicromatado

Ø mm	50	60	70	80	90	100
A mm	17	17	20	20	20	20
C mm	19	24	33	33		33
H mm	58	63	77	95	100	105
D mm	10	12	14	14	14	14
Portata 2 ruote Force 2 roues Kg. Capacity 2 wheels Capacidad 2 poleas	120	150	200	300	300	350
CODICE ART.	385050	385060	385070	385080	385090	385100
N° Pcs	1	1	1	1	1	1
Kg.	0,450	0,550	0,750	0,900	1,100	1,300

**Ruote con supporto esterno / Roues avec support exterieur
Wheels with external support / Poleas con soporte superior**

Ruota con supporto esterno - 1 cuscinetto - Gola Tonda Ø 20

Art. 385/L

Roues avec support exterieur- 1 roulement à billes - Gorge ronde Ø 20
Wheels with external support - 1 ball bearing - Round groove Ø 20
Poleas con soporte superior - 1 rodamiento de bolas - Canal redondo Ø 20

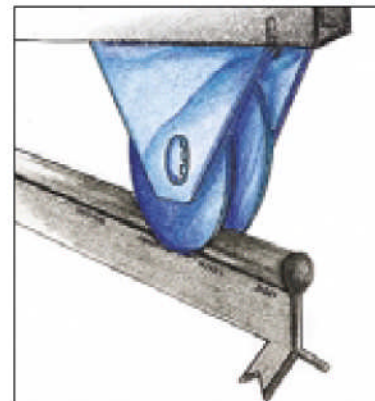
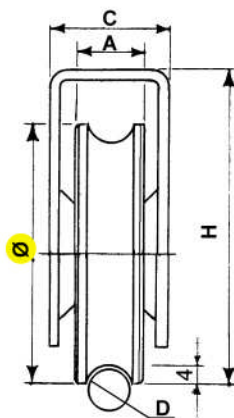

In acciaio tropicalizzato
En acier bichromaté
Yellow galvanized steel
Hierro bicromatado

Ø mm	80	90	100
A mm	25	25	25
C mm	36	36	36
H mm	95	100	105
D mm	20	20	20
Portata 2 ruote Force 2 roues Kg. Capacity 2 wheels Capacidad 2 poleas	300	300	400
CODICE ART.	385080L	385090L	385100L
N° Pcs	1	1	1
Kg.	0,900	1,100	1,300

Ruota con supporto esterno - 1 cuscinetto - Gola Tonda Ø 16

Art. 385/P

Roues avec support exterieur - 1 roulement à billes - Gorge ronde Ø 16
Wheels with external support - 1 ball bearing - Round groove Ø 16
Poleas con soporte superior - 1 rodamiento de bolas - Canal redondo Ø 16

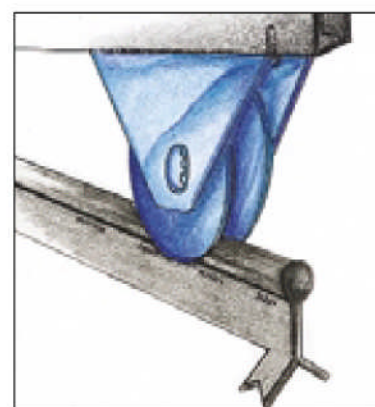
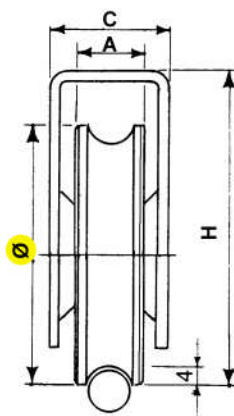

In acciaio tropicalizzato
En acier bichromaté
Yellow galvanized steel
Hierro bicromatado

Ø mm	80	90	100
A mm	22	22	22
C mm	36	36	36
H mm	95	100	105
D mm	16	16	16
Portata 2 ruote Force 2 roues Kg. Capacity 2 wheels Capacidad 2 poleas	300	300	400
CODICE ART.	385080P	385090P	385100P
N° Pcs	1	1	1
Kg.	0,900	1,100	1,300

**Ruote con piastra / Roues avec plaques
Wheels with plates / Poleas con soporte lateral**

Ruota con piastra - 1 cuscinetto - Gola V

Art. 388



In acciaio tropicalizzato
En acier bichromaté
Yellow galvanized steel
Hierro bicromatado

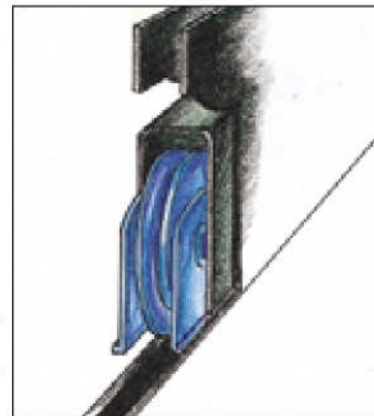
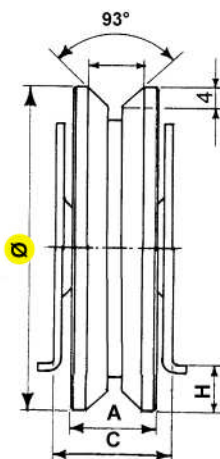

**Roues avec plaques - 1 roulement à billes - Gorge V
Wheels with plates - 1 ball bearing - Groove V
Poleas con soporte lateral - 1 rodamiento de bolas - Canal V**

Ø mm	60	70	80	90	100	120	140
A mm	17	20	20	20	20	20	25
C mm	23	33	33	33	33	33	34
H mm	11	16	15	20	25	18	28
Portata 2 ruote Force 2 roues Kg. Capacity 2 wheels Capacidad 2 poleas	150	200	300	300	350	400	600
CODICE ART.	388060	388070	388080	388090	388100	388120	388140
N° Pcs	1	1	1	1	1	1	1
Kg.	0,300	0,500	0,800	0,950	1,100	1,900	2,900

Ruota con piastra - 1 cuscinetto - Gola Tonda

Art. 387



In acciaio tropicalizzato
En acier bichromaté
Yellow galvanized steel
Hierro bicromatado

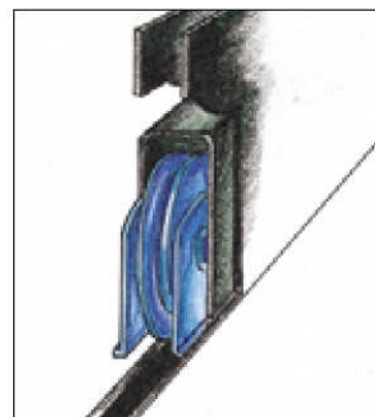
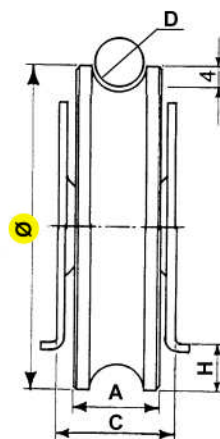

**Roues avec plaques - 1 roulement à billes - Gorge ronde
Wheels with plates - 1 ball bearing - Round groove
Poleas con soporte lateral - 1 rodamiento de bolas - Canal redondo**

Ø mm	60	70	80	90	100	120	140
A mm	17	20	20	20	20	20	25
C mm	23	33	33	33	33	33	34
H mm	11	16	15	20	25	18	28
D mm	12	14	14	14	14	14	20
Portata 2 ruote Force 2 roues Kg. Capacity 2 wheels Capacidad 2 poleas	150	200	300	300	350	400	600
CODICE ART.	387060	387070	387080	387090	387100	387120	387140
N° Pcs	1	1	1	1	1	1	1
Kg.	0,300	0,500	0,800	0,950	1,100	1,900	2,900

**Ruote con piastra / Roues avec plaques
Wheels with plates / Poleas con soporte lateral**

Ruota con piastra - 1 cuscinetto - Gola Tonda Ø 20

Art. 387/L

Roues avec plaques - 1 roulement à billes - Gorge ronde Ø 20
Wheels with plates - 1 ball bearing - Round groove Ø 20
Poleas con soporte lateral - 1 rodamiento de bolas - Canal redondo Ø 20

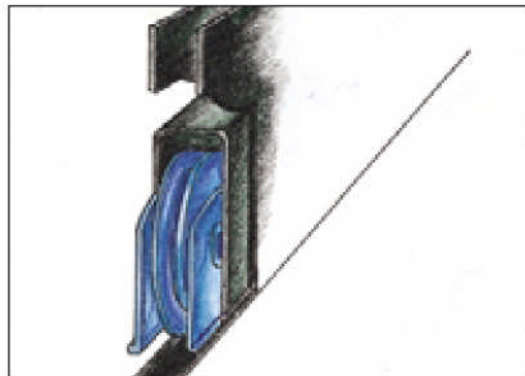
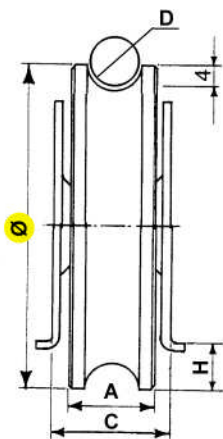

In acciaio tropicalizzato
En acier bichromaté
Yellow galvanized steel
Hierro bicromatado

Ø mm	80	90	100	120	140
A mm	25	25	25	25	25
C mm	34	34	34	34	34
H mm	15	20	25	18	28
D mm	20	20	20	20	20
Portata 2 ruote Force 2 roues Kg. Capacity 2 wheels Capacidad 2 poleas	300	300	350	400	600
CODICE ART.	387080L	387090L	387100L	387120L	387140L
N° Pcs	1	1	1	1	1
Kg.	0,800	1,000	1,300	2,000	2,500

Ruota con piastra - 1 cuscinetto - Gola Tonda Ø 16

Art. 387/P

Roues avec plaques - 1 roulement à billes - Gorge ronde Ø 16
Wheels with plates - 1 ball bearing - Round groove Ø 16
Poleas con soporte lateral - 1 rodamiento de bolas - Canal redondo Ø 16

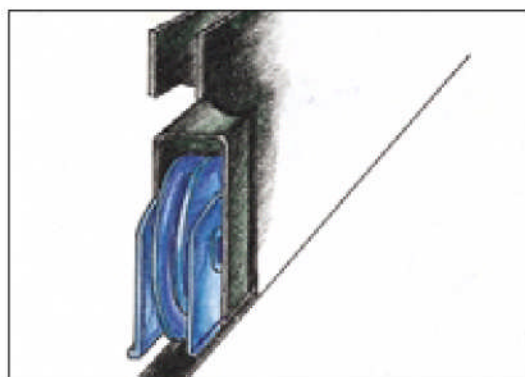
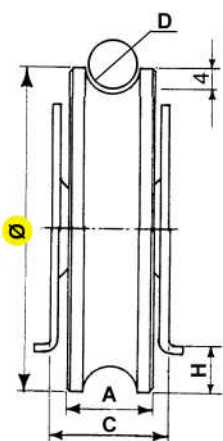

In acciaio tropicalizzato
En acier bichromaté
Yellow galvanized steel
Hierro bicromatado

Ø mm	60	70	80	90	100	120
A mm	22	22	22	22	22	22
C mm	33	33	33	33	33	33
H mm	11	16	15	20	25	18
D mm	16	16	16	16	16	16
Portata 2 ruote Force 2 roues Kg. Capacity 2 wheels Capacidad 2 poleas	150	200	300	300	350	400
CODICE ART.	387060P	387070P	387080P	387090P	387100P	387120P
N° Pcs	1	1	1	1	1	1
Kg.	0,600	0,700	0,800	1,000	1,250	1,800

**Ruote con piastra / Roues avec plaques
Wheels with plates / Poleas con soporte lateral**

Art. 387/A

Ruota con piastra - 2 cuscinetti1 - Gola Tonda Ø 20

Roues avec plaques - 2 roulements à billes - Gorge ronde Ø 20

Wheels with plates - 2 ball bearing - Round groove Ø 20

Poleas con soporte lateral - 2 rodamientos de bolas - Canal redondo Ø 20

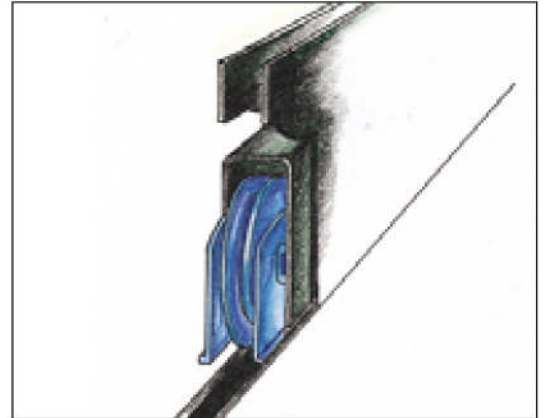
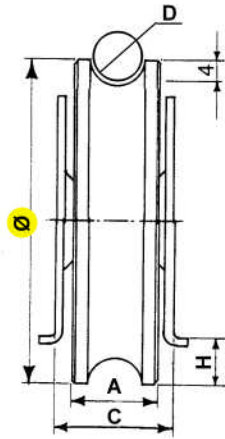

In acciaio tropicalizzato
En acier bichromaté
Yellow galvanized steel
Hierro bicromatado

Ø mm	80	90	100	120	140
A mm	30	30	30	30	30
C mm	44	44	44	44	44
H mm	15	20	25	18	28
D mm	20	20	20	20	20
Portata 2 ruote Force 2 roues Kg. Capacity 2 wheels Capacidad 2 poleas	400	400	500	700	800
CODICE ART.	387080A	387090A	387100A	387120A	387140A
N° Pcs	1	1	1	1	1
Kg.	1,250	1,350	1,500	2,450	3,400

Art. 388/A

Ruota con piastra - 2 cuscinetti1 - Gola V

Roues avec plaques - 2 roulements à billes - Gorge V

Wheels with plates - 2 ball bearing - Groove V

Poleas con soporte lateral - 2 rodamientos de bolas - Canal V

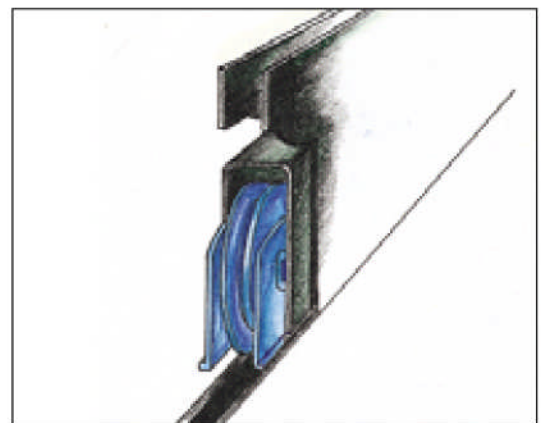
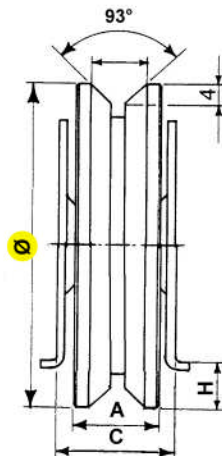

In acciaio tropicalizzato
En acier bichromaté
Yellow galvanized steel
Hierro bicromatado

Ø mm	80	90	100	120	140
A mm	30	30	30	30	30
C mm	44	44	44	44	44
H mm	15	20	25	18	28
Portata 2 ruote Force 2 roues Kg. Capacity 2 wheels Capacidad 2 poleas	400	400	500	700	800
CODICE ART.	388080A	388090A	388100A	388120A	388140A
N° Pcs	1	1	1	1	1
Kg.	1,300	1,450	1,600	2,550	3,500

Art. 393

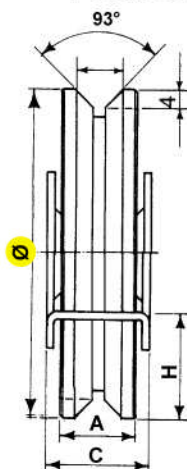

In acciaio tropicalizzato
En acier bichromaté
Yellow galvanized steel
Hierro bicromatado

Ø mm	80	90	100	120	140
A mm	20	20	20	20	25
C mm	33	33	33	34	34
H mm	20	25	30	39	44
Portata 2 ruote Force 2 roues Kg. Capacity 2 wheels Capacidad 2 poleas	250	250	300	400	600
CODICE ART.	393080	393090	393100	393120	393140
N° Pcs	1	1	1	1	1
Kg.	0,850	0,950	1,200	1,900	2,950

Art. 392

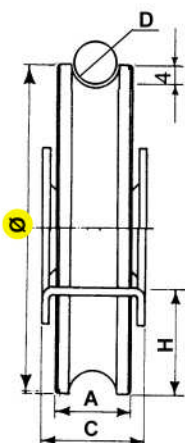

In acciaio tropicalizzato
En acier bichromaté
Yellow galvanized steel
Hierro bicromatado

Ø mm	80	90	100	120	140
A mm	20	20	20	20	20
C mm	33	33	33	34	34
H mm	20	25	30	39	44
D mm	14	14	14	14	14
Portata 2 ruote Force 2 roues Kg. Capacity 2 wheels Capacidad 2 poleas	250	250	300	400	600
CODICE ART.	392080	392090	392100	392120	392140
N° Pcs	1	1	1	1	1
Kg.	0,800	0,950	1,200	1,900	2,900

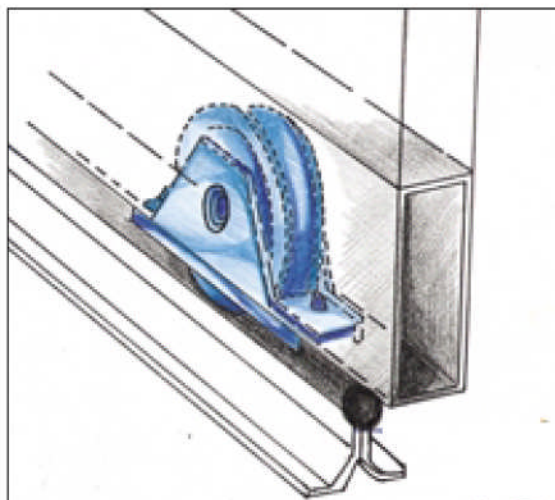

**Ruote con supporto interno / Roues avec support interieur
Wheels with internal support / Poleas con soporte interior**

Ruota con supporto interno - 1 cuscinetto - Gola Tonda Ø 20

Art. 392/L

**Roues avec support interieur - 1 roulement à billes - Gorge ronde Ø 20
Wheels with internal support - 1 ball bearing - Round groove Ø 20
Poleas con soporte interior - 1 rodamiento de bolas - Canal redondo Ø 20**

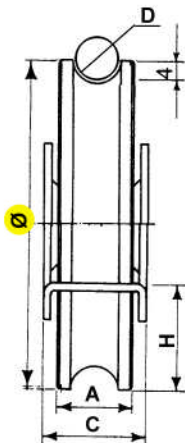

In acciaio tropicalizzato
En acier bichromaté
Yellow galvanized steel
Hierro bicromatado

Ø mm	80	90	100	120	140
A mm	25	25	25	25	25
C mm	34	34	34	34	34
H mm	15	20	25	18	28
D mm	20	20	20	20	20
Portata 2 ruote Force 2 roues Kg. Capacity 2 wheels Capacidad 2 poleas	250	250	300	400	600
CODICE ART.	392080L	392090L	392100L	392120L	392140L
N° Pcs	1	1	1	1	1
Kg.	0,900	1,000	1,200	1,900	2,900

Ruota con supporto interno - 1 cuscinetto - Gola Tonda Ø 16

Art. 392/P

**Roues avec support interieur - 1 roulement à billes - Gorge ronde Ø 16
Wheels with internal support - 1 ball bearing - Round groove Ø 16
Poleas con soporte interior - 1 rodamiento de bolas - Canal redondo Ø 16**

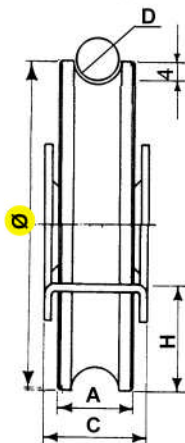

In acciaio tropicalizzato
En acier bichromaté
Yellow galvanized steel
Hierro bicromatado

Ø mm	80	90	100	120
A mm	22	22	22	22
C mm	33	33	33	33
H mm	15	20	25	18
D mm	16	16	16	16
Portata 2 ruote Force 2 roues Kg. Capacity 2 wheels Capacidad 2 poleas	250	250	300	400
CODICE ART.	392080P	392090P	392100P	392120P
N° Pcs	1	1	1	1
Kg.	0,800	0,900	1,000	1,200

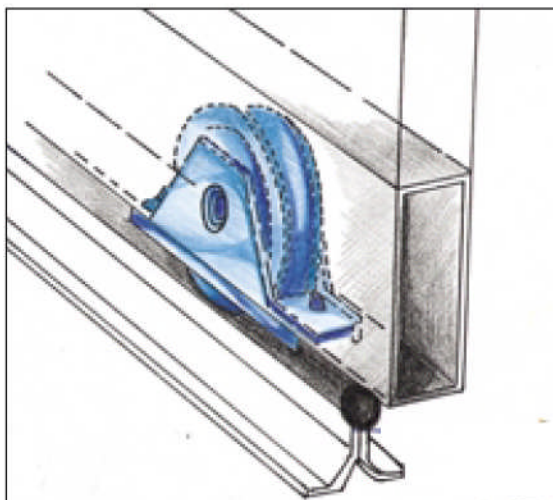

**Ruote con supporto interno / Roues avec support interieur
Wheels with internal support / Poleas con soporte interior**

Ruota con supporto interno - 2 cuscinetti - Gola Tonda Ø 20

Art. 392/A

**Roues avec support interieur - 2 roulements à billes - Gorge ronde Ø 20
Wheels with support internal support - 2 ball bearing - Round groove Ø 20
Poleas con soporte interior - 2 rodamientos de bolas - Canal redondo Ø 20**

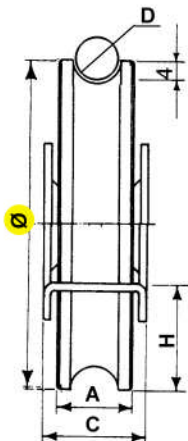

In acciaio tropicalizzato
En acier bichromaté
Yellow galvanized steel
Hierro bicromatado

Ø mm	80	90	100	120	140
A mm	25	25	25	28	28
C mm	34	34	34	37	37
H mm	20	25	30	39	44
D mm	20	20	20	20	20
Portata 2 ruote Force 2 roues Kg. Capacity 2 wheels Capacidad 2 poleas	400	400	500	700	800
CODICE ART.	392080A	392090A	392100A	392120A	392140A
N° Pcs	1	1	1	1	1
Kg.	1,000	1,200	1,350	1,500	3,400

Ruota con supporto interno - 2 cuscinetti - Gola V

Art. 393/A

**Roues avec support interieur - 2 roulements à billes - Gorge V
Wheels with internal support - 2 ball bearing - Groove V
Poleas con soporte interior - 2 rodamientos de bolas - Canal V**

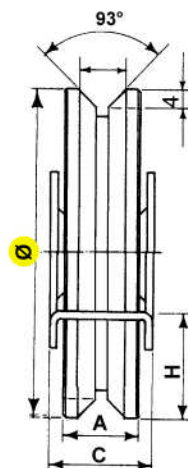

In acciaio tropicalizzato
En acier bichromaté
Yellow galvanized steel
Hierro bicromatado

Ø mm	80	90	100	120	140
A mm	20	20	20	20	25
C mm	34	34	34	34	34
H mm	20	25	25	39	44
Portata 2 ruote Force 2 roues Kg. Capacity 2 wheels Capacidad 2 poleas	400	400	500	700	800
CODICE ART.	393080A	393090A	393100A	393120A	393140A
N° Pcs	1	1	1	1	1
Kg.	1,000	1,200	1,350	1,500	3,400

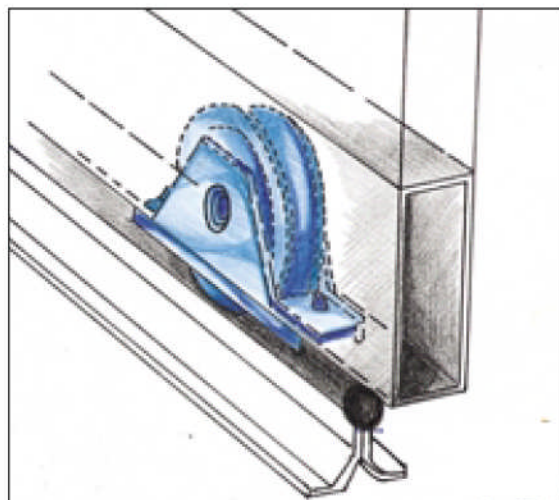

Art. 368

Ruote per cavo

Roues pour cables
Wheels for cable
Poleas por cable

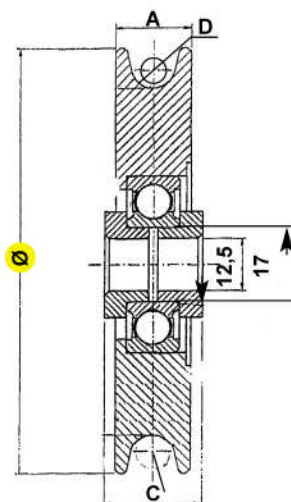

In acciaio tropicalizzato
En acier bichromaté
Yellow galvanized steel
Hierro bicromatado

Ø mm	80	100	120
A mm	14	17	17
C mm	22	22	22
D mm	6	8	8
CODICE ART.	368080	368100	368120
N° Pcs	1	1	1
Kg.	0,700	0,850	1,000

Art. 360/Q

Ruota - 1 cuscinetto - Gola Quadra

Roues - 1 roulement à billes - Gorge carre
Wheels - 1 ball bearing - Square groove
Poleas - 1 rodamiento de bolas - Canal cuadrado

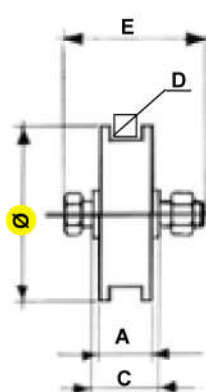

In acciaio tropicalizzato
En acier bichromaté
Yellow galvanized steel
Hierro bicromatado

Ø mm	50	60	70	80	90	100	120
A mm	17	17	20	20	20	20	20
C mm	19	24	24	33	33	33	33
E mm	10x45	10x45	14x60	14x60	14x60	14x60	14x60
D mm	8	8	8	8	8	8	8
Portata 2 ruote Force 2 roues Capacity 2 wheels Capacidad 2 poleas	120	200	300	300	300	400	400
CODICE ART.	360050Q	360060Q	360070Q	360080Q	360090Q	360100Q	360120Q
N° Pcs	1	1	1	1	1	1	1
Kg.	0,200	0,370	0,650	0,750	0,950	1,100	1,700

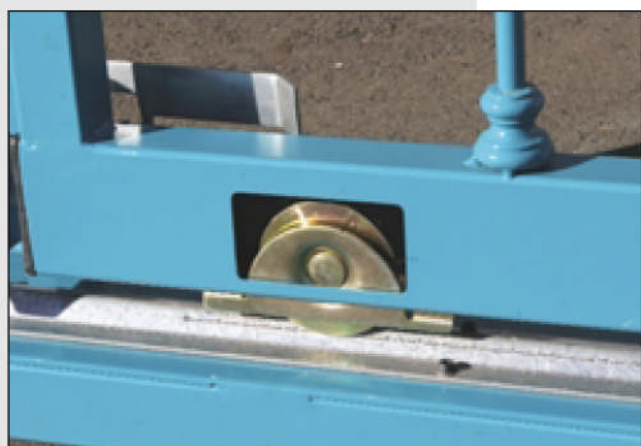

Art. 370-370/S-370/A



Art. 370-370/S
acciaio zincato
acier galvanize
galvanized steel
Hierro cingado

Art.	370	370/S
A mm	19	17
SP mm	4	3
Barre Barres Pieces Barras	3 mt.	3 mt.
CODICE ART.	370	370S
N° Pcs	1	1
Kg.	13,000	10,000

Art. 370/A
Giunzione
Junction
Joint
jonction

Art.	370/A
CODICE ART.	370/A

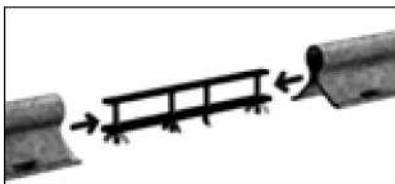

Rotaia per cancelli

Rail pour portails
Wheel track
Rail por cancela

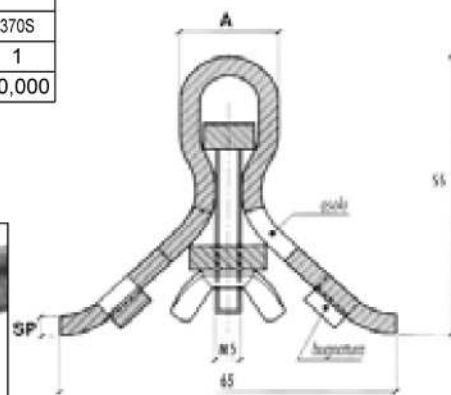

Art. 365-365/A



Art. 365

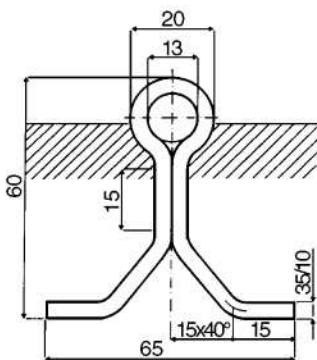

Art. 365

rotaia acciaio zincato
rail acier galvanize
track galvanized steel
hierro cingado

Art.	365
Barre Barres Pieces Barras	3 mt.
CODICE ART.	365
N° Pcs	1
Kg.	13,500

Rotaia per cancelli

Rail pour portail
Wheel track
Rail por cancela

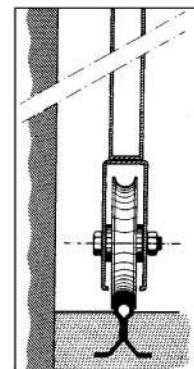

Art. 365/A

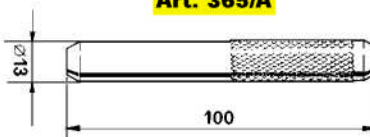

Art. 365/A

perno di giunzione
junction
connection pin
pernio de jonction

Art.	365/A
CODICE ART.	365A

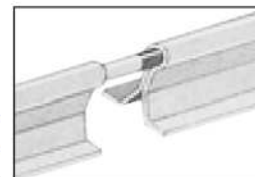

Art. 369-369/P



acciaio zincato
acier galvanize
galvanized steel
hierro cingado

Art.	369	369/P
Barre Barres Pieces Barras	3 mt.	3 mt.
CODICE ART.	369	369P
N° Pcs	1	1
Kg.	7,000	6,000

Rotaia per cancelli da avvitare - profilo tondo U

Rail à visser pour portail - profil rond
Wheel track to be screwed - round shape
Rail por cancela por atornillar - perfil redondo

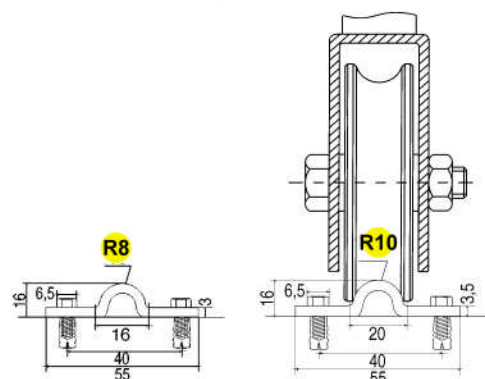

Art. 369/P

Art. 369