

New



# INDUSTRIA BRIANTEA FERRAMENTA MINUTERIE



ARTICOLI PER LEGNO - ARTICLES POUR MENUISERIE EN BOIS  
ARTICLES FOR WOODEN CARPENTRY - ARTICULOS POR MADERA

ARTICOLI PER FERRO - ARTICLES POUR MENUISERIE EN FER  
ARTICLES FOR STEEL CARPENTRY - ARTICULOS POR HIERRO

ARTICOLI IN ACCIAIO INOX - ART. EN ACIER INOX  
ITEMS IN STAINLESS STEEL - ARTICULOS EN ACERO INOXIDABLE

ARTICOLI PER LEGNO - FERRO - ALLUMINIO - ARTICLES ADAPTABLES POUR MENUISERIE EN FER - BOIS - ALUMINIUM  
ARTICLES SUITABLES FOR WOODEN - STEEL - ALUMINIUM CARPENTRY - ARTICULOS POR MADERA - HIERRO - ALUMINIO

ARTICOLI PER ALLUMINIO - ARTICLES POUR MENUISERIE EN ALUMINIUM  
ARTICLES FOR ALUMINIUM CARPENTRY - ARTICULOS POR ALUMINIO

ARTICOLI DI FERRAMENTA VARIA - ARTICLES VARIÉS POUR QUINCAILLERIE  
VARIOUS HARDWARE ARTICLES - ARTICULOS VARIADOS DE FERRETERIA

**Nuovi articoli**  
Nouveautés  
New products  
Novedades

Gennaio 2006



FERRO - FER  
STEEL - HIERRO

## Cerniera invisibile regolabile 3D per profili in ferro

Art. 752-753

752/i-753/i

Charniere invisible réglable 3D pour profils en acier  
invisible hinge with 3D regulations for steel profile  
Bisagra invisible con regulacion 3D por perfiles en hierro



ART. 752



ART. 753

**Art. 752**

a due ali - acciaio verniciato nero  
2 volets - en acier verni noir  
2 wings - steel lackered black  
2 piezas - hierro pintado negro

**Art. 752/i**

a 2 ali INOX  
2 volets INOX  
2 wings INOX  
2 piezas INOX

**Art. 753/i**

a 3 ali INOX  
3 volets INOX  
3 wings INOX  
3 piezas INOX

completa di viti  
avec vis  
with screws  
completa con tornillos

**Art. 753**

a tre ali  
acciaio verniciato nero  
3 volets  
en acier verni noir  
3 wings  
steel lackered black  
3 piezas  
hierro pintado negro

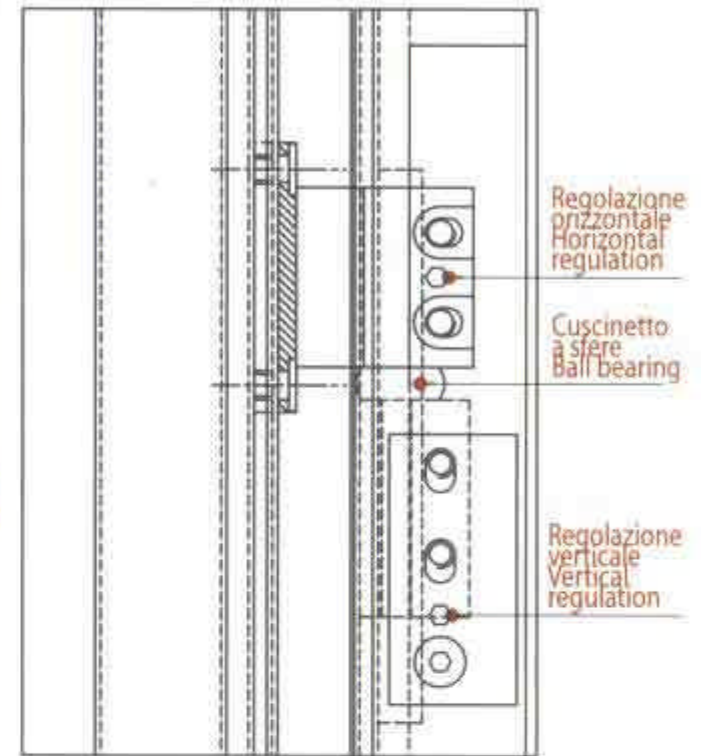

| Art.                                 | 752 | 752/i | 753 | 753/i |
|--------------------------------------|-----|-------|-----|-------|
| PORTATA<br>FORCE<br>WEIGHT<br>FUERZA | 120 | 120   | 150 | 150   |
| CODICE ART.                          | 752 | 752i  | 753 | 753i  |
| N° Pcs                               | 2   | 2     | 2   | 2     |
| Kg.                                  |     |       |     |       |

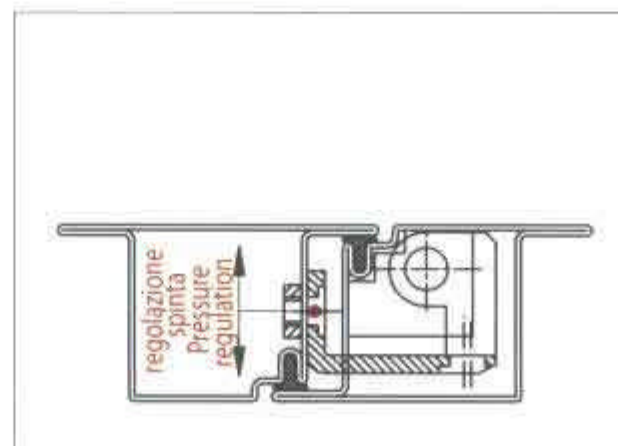
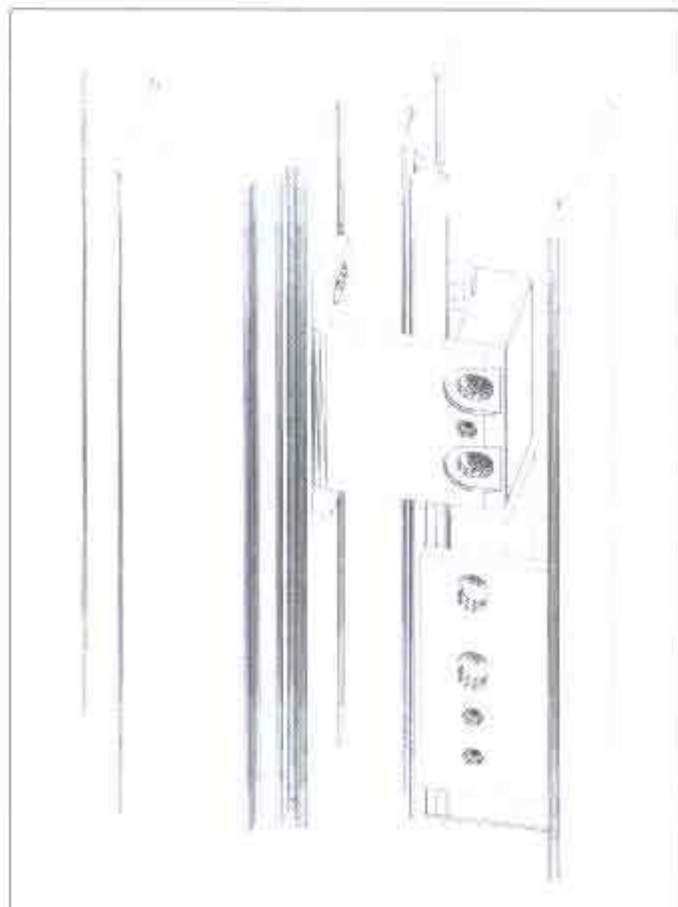
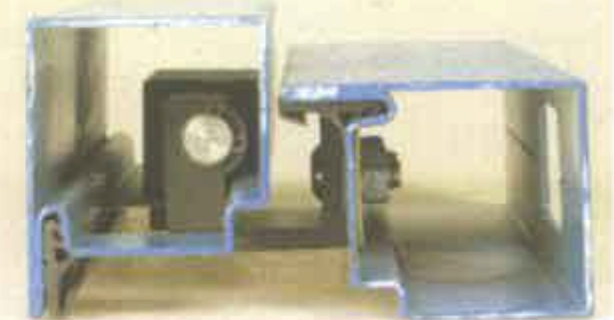

Chiusa - Fermé  
Closed - Cerradas

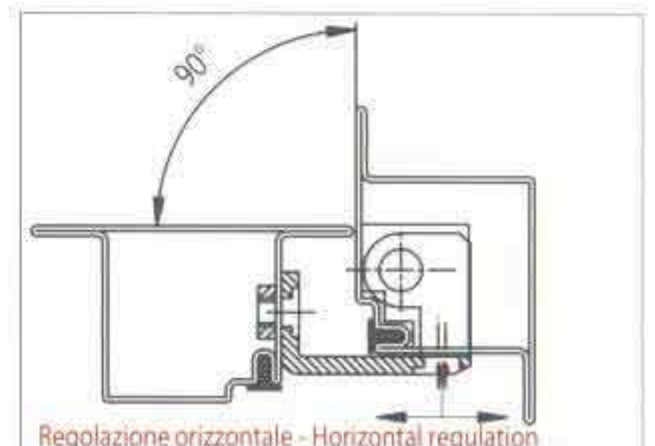

Aperto - Ouvert  
Open - Abiertas

## Cerniere per porte pesanti e tagliafuoco con coperchio avvitato

**Art. 742-743**  
**743/i-743/M**

Charniere pour portes lourdes et coupe feu  
Special hinge for heavy doors and fire doors  
Pernios para puertas corta fuego

ART. 742



ART. 743



ART. 743



ART. 743/M

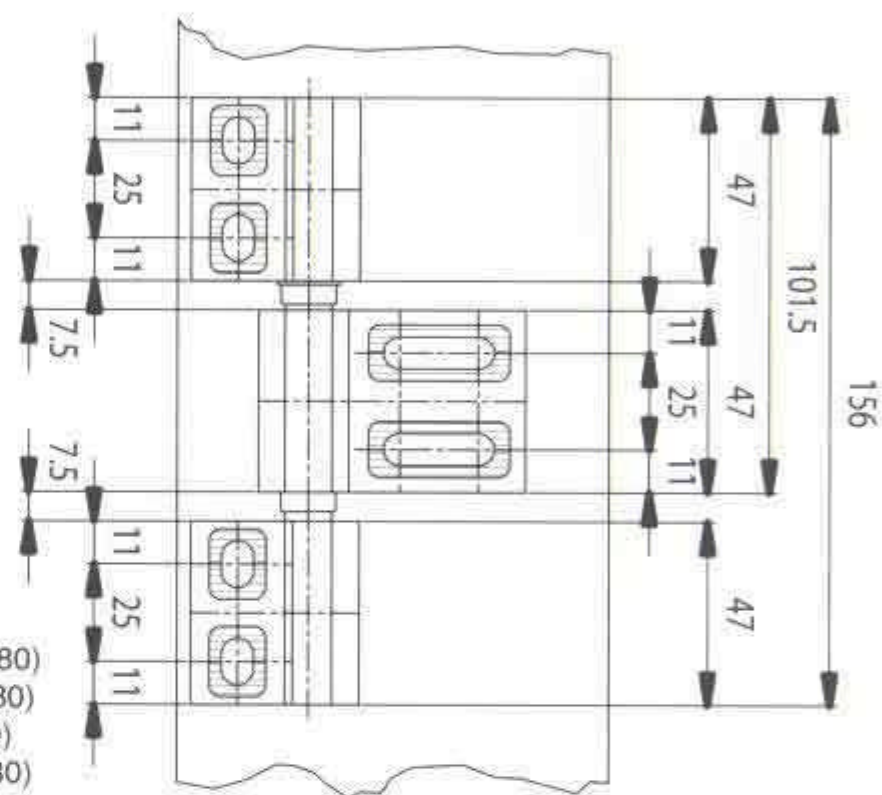
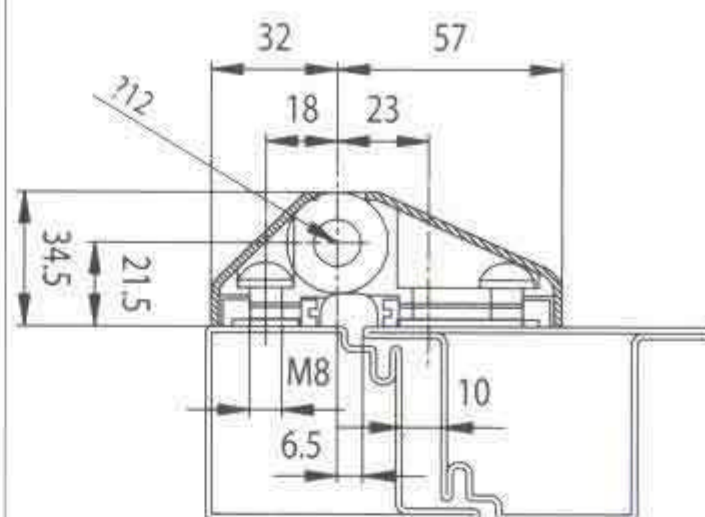

**Art. 742**

a due ali (portata 2 cerniere kg.80)  
2 volets (force 2 charnieres kg.80)  
2 wings (max door weight kg.80)  
2 piezas (fuerza 2 pernios Kg. 80)

**Art. 743**

a tre ali (portata 2 cerniere kg.150)  
3 volets (force 2 charnieres kg.150)  
3 wings (max door weight kg.150)  
3 piezas (fuerza 2 pernios Kg.150)

**Art. 743/M**

a 3 ali con molla di chiusura  
3 volets avec ressort pour fermeture  
3 wings with self closing spring  
3 piezas con muelles

**Art. 743/i**

a 3 ali INOX  
3 volets INOX  
3 wings INOX  
3 piezas INOX

| Art.        | 742 | 743 | 743/i | 743/M |
|-------------|-----|-----|-------|-------|
| CODICE ART. | 742 | 743 | 743i  | 743M  |
| N° Pcs      | 2   | 2   | 2     | 2     |
| Kg.         |     |     |       |       |

## Coordinatore di chiusura per porte a doppia anta

Coordinateur de fermeture pour portes double battent  
Door closing coordinator for 2 leaf doors  
Coordinador de cierre para puertas de 2 battientes

**Art. 136**



in ferro verniciato nero  
in fer verni noir  
black lackered steel  
hierro pintado negro

| Art.        | 136 |
|-------------|-----|
| CODICE ART. | 136 |
| N° Pcs      |     |
| Kg.         |     |



Tappino in gomma

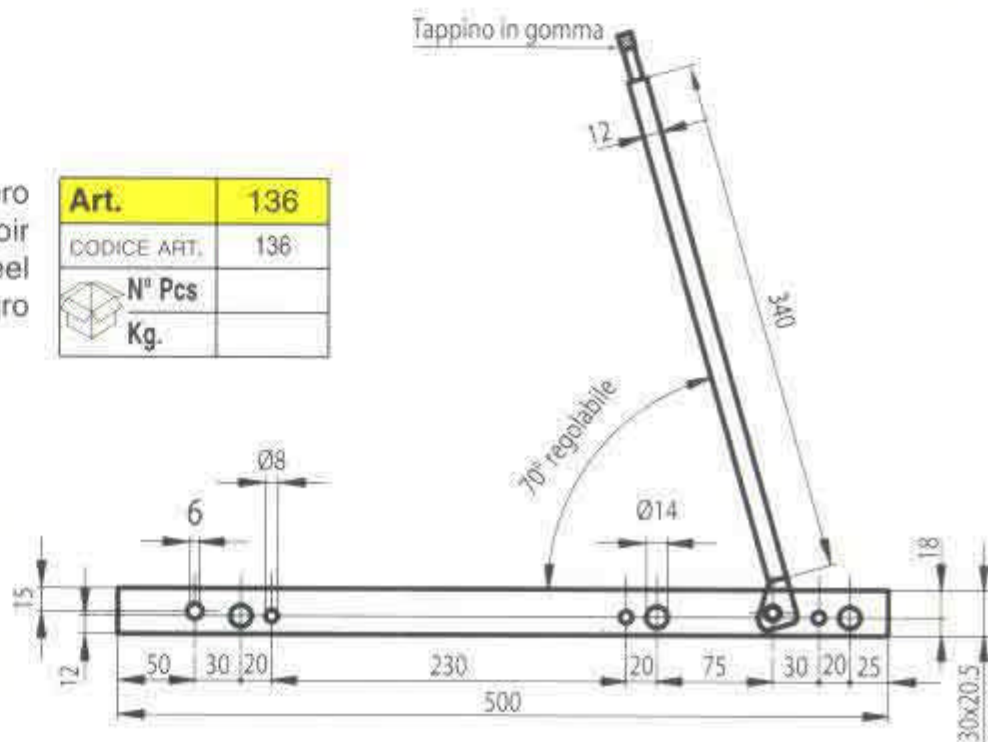



FERRO - FER  
STEEL - HIERRO

## Cardine a cuscinetti con regolazione a viti Ø 45

### Art. 838/P-839/P



Art. 838/P

Art. 839/P

in acciaio tropicalizzato  
acier bichromaté  
yellow galvanized steel  
hierro bicromatado

portata 1 coppia kg. 150  
poids maximum portail kg. 150  
maximum weight load kg. 150  
fuerza 1 juego Kg. 150

|             |         |       |
|-------------|---------|-------|
| Art.        | 538/P   | 539/P |
| Ø mm        | 45      |       |
| B mm        | 75      |       |
| CODICE ART. | 538539P |       |
| N° Pcs      | 1+1     |       |
| Kg.         | 1,020   |       |

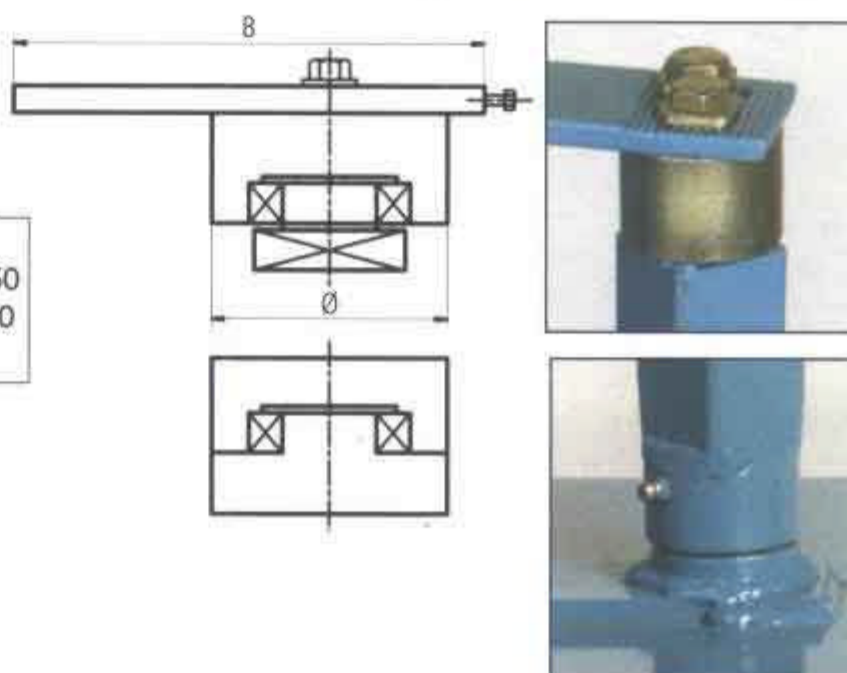

Pivot avec roulements à billes réglage à vis - Ø 45  
Ball bearing hinge for gates regulation through screw - Ø 45  
Punto de giro con rodamiento de bolas regulable con tornillo - Ø 45

## Cardine a cuscinetti con regolazione a vite - Ø 50

### Art. 838-839



Art. 838

Art. 839

In acciaio tropicalizzato  
Acier bichromaté  
Yellow galvanized steel  
hierro bicromatado

|             |        |     |
|-------------|--------|-----|
| Art.        | 538    | 539 |
| Ø mm        | 50     |     |
| B mm        | 140    |     |
| CODICE ART. | 538539 |     |
| N° Pcs      | 1+1    |     |
| Kg.         | 1,700  |     |

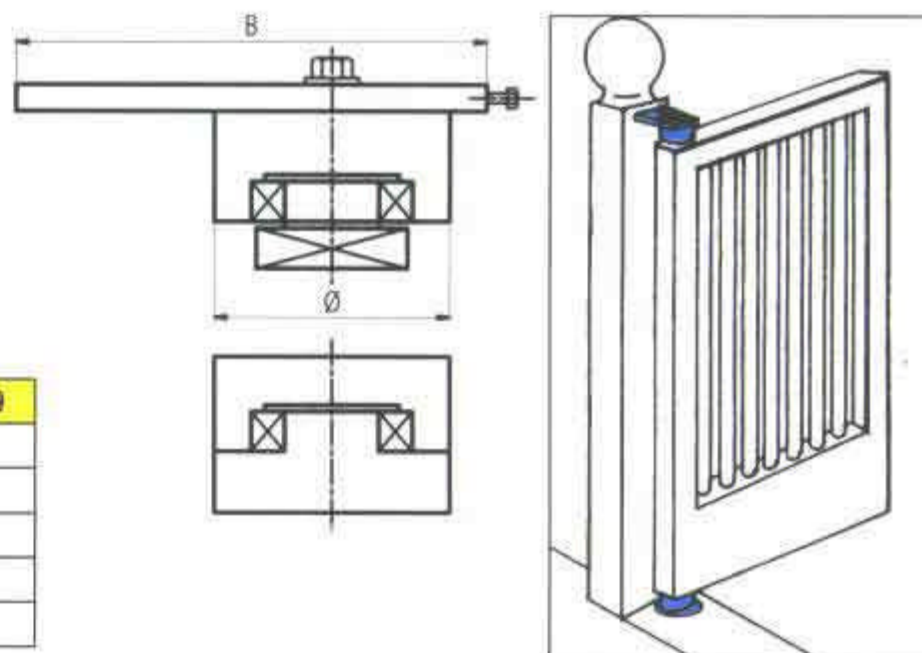

Pivot avec roulements à billes réglage à vis - Ø 50  
Ball bearing hinge for gates regulation through screw - Ø 50  
Punto de giro con rodamiento de bolas regulable con tornillo - Ø 50

## Cardine a cuscinetti con regolazione a vite - Ø 70

### Art. 848-849



Art. 848

Art. 849

In acciaio tropicalizzato  
Acier bichromaté  
Yellow galvanized steel  
hierro bicromatado

|             |        |     |
|-------------|--------|-----|
| Art.        | 548    | 549 |
| Ø mm        | 70     |     |
| B mm        | 150    |     |
| CODICE ART. | 548549 |     |
| N° Pcs      | 1+1    |     |
| Kg.         | 2,000  |     |

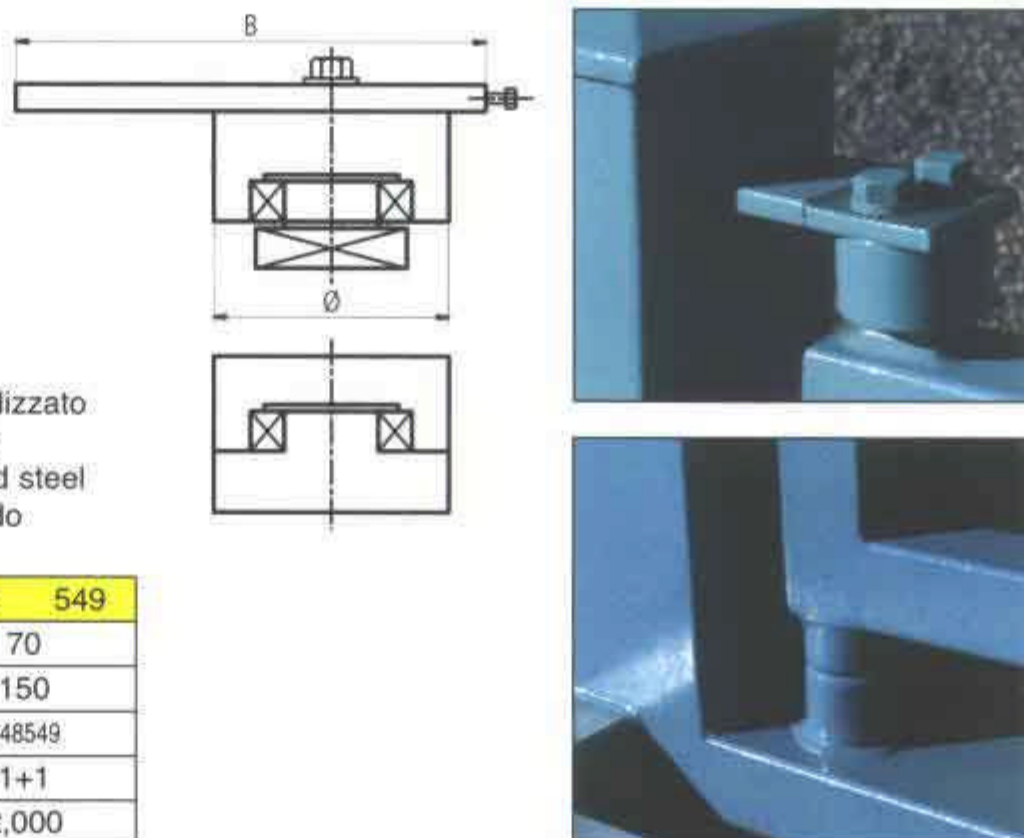

Pivot avec roulements à billes réglage à vis - Ø 70  
Ball bearing hinge for gates regulation through screw - Ø 70  
Punto de giro con rodamiento de bolas regulable con tornillo - Ø 70

**Art. 527/A-527/BS-527/BD**



**Art. 527/BS**  
SINISTRE  
GAUCHES  
LEFT  
IZQUIERDA

**Art. 527/A**  
AMBIDESTRO  
DOUBLE COTÉ  
DOUBLE SIDE  
AMBIVALENTE

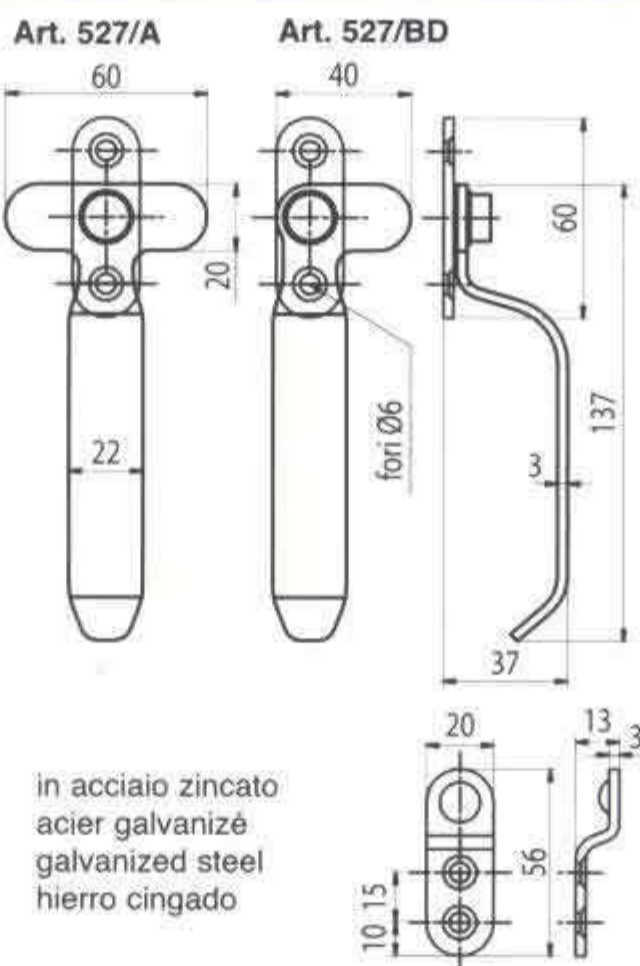

**Maniglia di blocco per finestre**

Poignee de blocage pour fenetres  
Window locking handle  
Manilla de bloqueo para ventanas

| Tipo<br>Type<br>Model | DESTRE<br>DROITES<br>RIGHT<br>DERECHA | SINISTRE<br>GAUCHES<br>LEFT<br>IZQUIERDA | AMBIDESTRO<br>DOUBLE COTÉ<br>DOUBLE SIDE<br>AMBIVALENTE |
|-----------------------|---------------------------------------|--|---|
| CODICE ART.           | 527BD                                 | 527BS                                    | 527A  |
| N° Pcs                | 10                                    | 10                                       | 10  |
| Kg.                   |                                       |  |   |

**Art. 527/A**  
ambidestro  
double coté  
double side  
ambivalente  
**Art. 527/BD**  
destre  
droites  
right  
derecha  
**Art. 527/BS**  
sinistre  
gauches  
left  
izquierda



**Art. 614**



**Coperchio copricerniera**

Couverture pour paumelles  
Cover for hinges  
Cubierta por pernios



(O) ottonata - laitonée - brass plated - latonado  
(C) cromato - chromé - chrome - cromado  
(CS) cromo satinato - chromé satin  
chrome mat - cromado satin

| Ø mm           | 20      | 22      |
|----------------|---------|---------|
| A mm           | 75      | 75      |
| COD. ART. (O)  | 61420O  | 61422O  |
| COD. ART. (C)  | 61420C  | 61422C  |
| COD. ART. (CS) | 61420CS | 61422CS |
| N° Pcs         |         |         |
| Kg.            |         |         |

**Art. 592-593-594-598**

**Copripilastrì in plastica Tipo quadro - tondo - rettangolare**

Couvertures en plastique pour piliers Type carré - rond - rectangulaire  
Plastic covers for pipes Square - round - rectangular model  
Tapos en plastico Tipo cuadro - redondo - rectangular



Art. 592

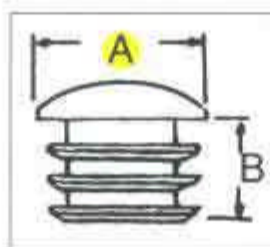

Art. 593

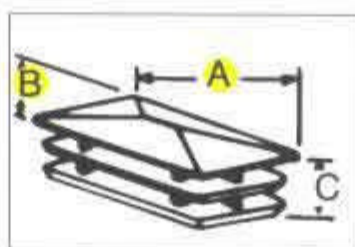

Art. 594

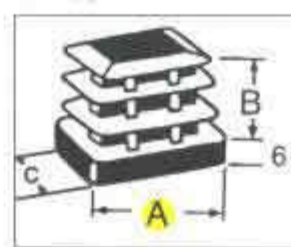

Art. 598

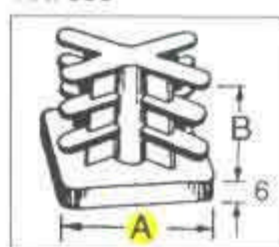

**Art. 592**

| AØ mm       | 16     | 32     | 100    |
|-------------|--------|--------|--------|
| B mm        | 9,5    | 16     | 29     |
| CODICE ART. | 592016 | 592032 | 592100 |
| N° Pcs      |        |        |        |
| Kg.         |        |        |        |

**Art. 593**

| AxB mm      | 20x80   | 25x50   |
|-------------|---------|---------|
| C mm        | 16      | 12      |
| CODICE ART. | 5932080 | 5932550 |
| N° Pcs      |         |         |
| Kg.         |         |         |

**Art. 594**

| AxC mm      | 20x50   | 20x60   | 30x80   |
|-------------|---------|---------|---------|
| B mm        | 13      | 19      | 17      |
| CODICE ART. | 5942050 | 5942060 | 5943080 |
| N° Pcs      |         |         |         |
| Kg.         |         |         |         |

**Art. 598**

| A mm        | 100    |
|-------------|--------|
| B mm        | 30     |
| CODICE ART. | 598100 |
| N° Pcs      |        |
| Kg.         |        |

**New Size**

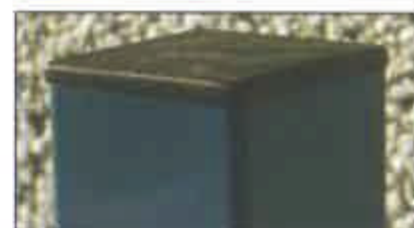

**Art. 1110**

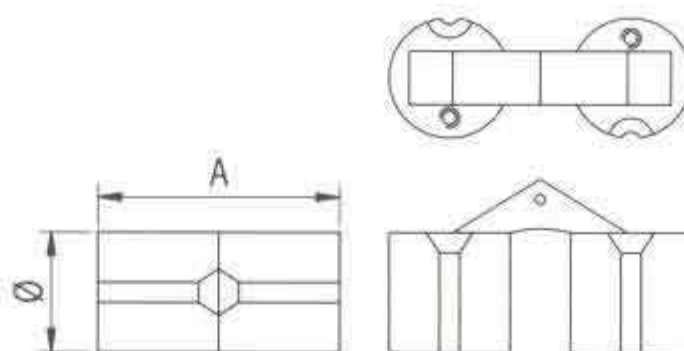

| Ø mm        | 10     | 12     | 14     | 16     | 18     | 24     |
|-------------|--------|--------|--------|--------|--------|--------|
| A mm        | 22     | 28     | 31     | 33     | 36     | 50     |
| CODICE ART. | 111010 | 111012 | 111014 | 111016 | 111018 | 111024 |
| N° Pcs      | 100    | 100    | 50     | 50     | 30     | 10     |
| Kg.         | 1,040  | 1,800  | 1,400  | 1,850  | 1,600  | 1,300  |

**Cerniere invisibili in ottone**

Charnières invisibles en laiton  
Invisible brass hinges  
Bisagras invisibles en laton

**Art. 659**



| A mm          | 140     | 230     |
|---------------|---------|---------|
| B mm          | 110     | 175     |
| COD. ART. (A) | 659140A | 659230A |
| COD. ART. (N) | 659140N | 659230N |
| COD. ART. (V) | 659140V | 659230V |
| COD. ART. (B) | 659140B | 659230B |
| COD. ART. (O) | 659140O | 659230O |
| N° Pcs        | 2       | 2       |
| Kg.           |         |         |

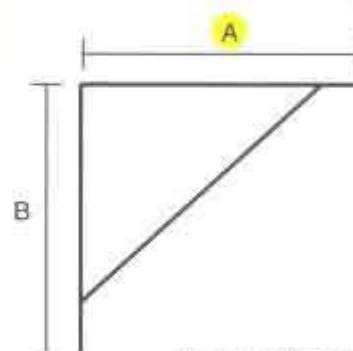

in acciaio verniciato  
acier laqué  
lackered steel  
en hierro pintado



COLORI-COULEURS  
COLOURS-ACABADOS:  
antracite (A)  
nero-noir-black-negro (N)  
verde antico-vert-antique green-verde antiguo (V)  
bronzo-bronze-bronze (B)  
ottone antico-laiton vieux-antique brass-laton antiguo (O)

**Mensola robusta in ferro battuto**

Console en style fer forgé model fort  
Wrought iron style shelf brackets  
Soporte fuerte modelo antiguo

**Art. 643/C-644/C-744/C**

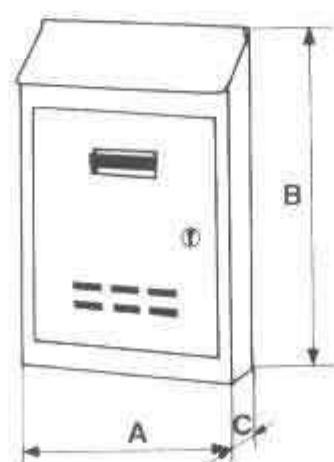

Boite a lettres avec cylindre  
Mail boxes with cylinder locks  
Buzon de correo con cilindro

**New Size**

| Art.        | 643/C | 644/C | 744/C |
|-------------|-------|-------|-------|
| A mm        | 175   | 200   | 230   |
| B mm        | 250   | 300   | 350   |
| C mm        | 50    | 60    | 80    |
| CODICE ART. | 643C  | 644C  | 744C  |
| N° Pcs      | 6     | 6     | 6     |
| Kg.         |       |       |       |

|   |   |
|---|---|
| STANDARD  | in ferro verniciato grigio<br>fer verni gris<br>steel grey painted<br>hierro pintado gris   |
| ALTRI COLORI A RICHIESTA<br>AUTRES COULEURS SUR DEMANDE<br>OTHERS COLOURS ON REQUEST<br>ACABADOS POR REQUESTA | bianco - verde - marrone - nero<br>blanc - vert - brun - noir<br>white - green - brown - black<br>blanco - verde - marron - negro |

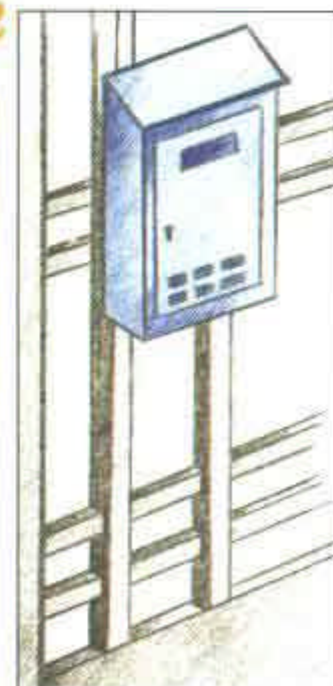

### Cerniere piane in ottone satinato e verniciate

**Art. 1101**

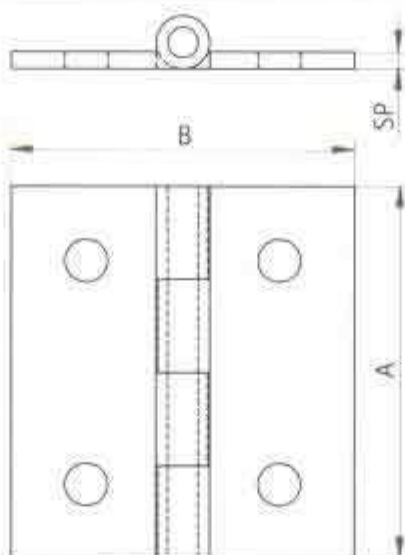

Charnieres en laiton satin et verni  
Brass satin hinges and lackered  
Bisagra en laton satin pintado

| AxB mm               | 25x25    | 30x25    | 30x30    | 35x30    | 35x35    | 40x35    | 40x40    | 50x40    | 50x50    | 60x50    | 70x55    |
|----------------------|----------|----------|----------|----------|----------|----------|----------|----------|----------|----------|----------|
| SPESSORE<br>TICKNESS | 1,6      | 1,6      | 1,6      | 1,6      | 1,6      | 1,6      | 1,8      | 1,8      | 2,0      | 2,0      | 2,0      |
| CODICE ART.          | 11012525 | 11013025 | 11013030 | 11013530 | 11013535 | 11014035 | 11014040 | 11015040 | 11015050 | 11016050 | 11017055 |
| N° Pcs               | 24       | 24       | 24       | 24       | 24       | 24       | 24       | 24       | 24       | 24       | 24       |
| Kg.                  |          |          |          |          |          |          |          |          |          |          |          |

### Cerniere mezzo collo in ottone satinato e verniciate

**Art. 1102**

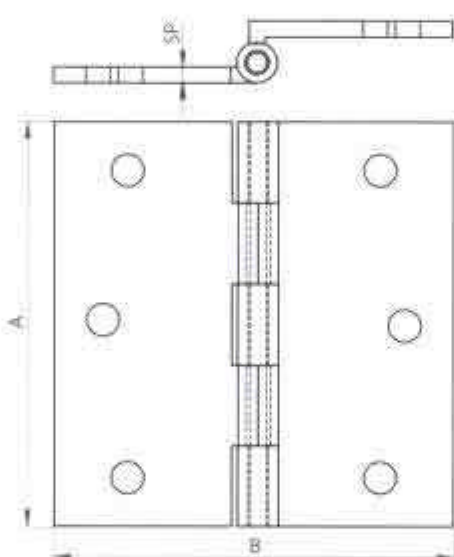

Charnieres en laiton satin et verni  
Brass satin hinges and lackered  
Bisagra en laton y satin pintado

| AxB mm               | 40x35    | 40x40    | 50x40    | 50x50    | 60x50    |
|----------------------|----------|----------|----------|----------|----------|
| SPESSORE<br>TICKNESS | 1,6      | 1,8      | 1,8      | 2,0      | 2,0      |
| CODICE ART.          | 11024035 | 11024040 | 11025040 | 11025050 | 11026050 |
| N° Pcs               | 24       | 24       | 24       | 24       | 24       |
| Kg.                  |          |          |          |          |          |

### Cerniere collo intero in ottone satinato e verniciate

**Art. 1103**

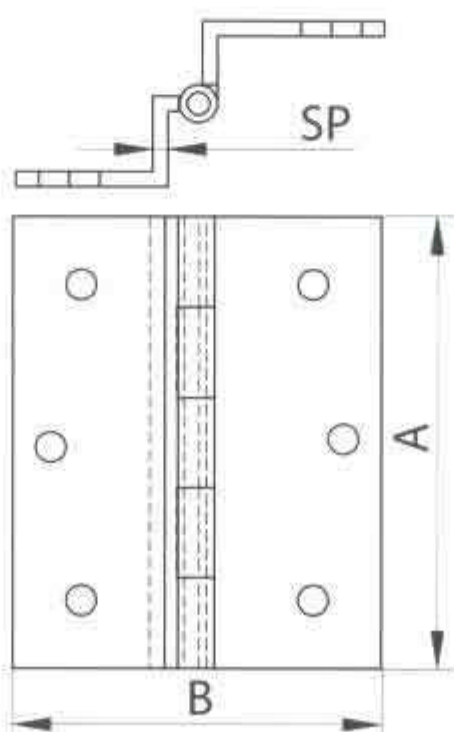

Charnieres en laiton satin et verni  
Brass satin hinges and lackered  
Bisagra en laton y satin pintado

| AxB mm               | 40x35    | 40x40    | 50x40    | 50x50    | 60x50    |
|----------------------|----------|----------|----------|----------|----------|
| SPESSORE<br>TICKNESS | 1,6      | 1,6      | 1,8      | 1,8      | 2,0      |
| CODICE ART.          | 11034035 | 11034040 | 11035040 | 11035050 | 11036050 |
| N° Pcs               | 24       | 24       | 24       | 24       | 24       |
| Kg.                  |          |          |          |          |          |

### Art. 12500

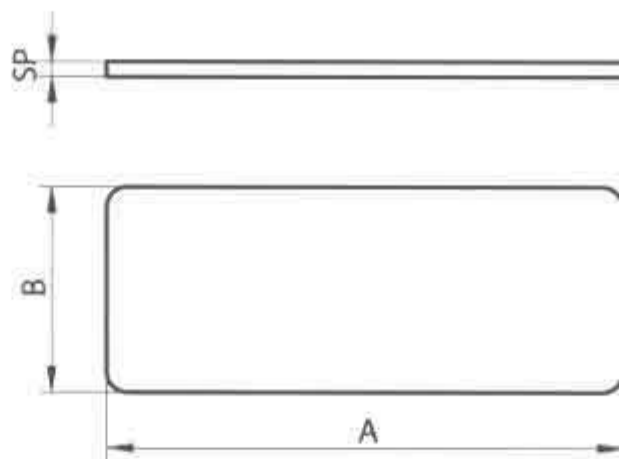

In acciaio tropicalizzato  
Acier bichromaté  
Steel yellow galvanized  
Hierro bicromatado

| A mm        | 80        | 100       | 120       | 120       | 160       | 160       | 200       | 200       |
|-------------|-----------|-----------|-----------|-----------|-----------|-----------|-----------|-----------|
| B mm        | 40        | 40        | 40        | 60        | 60        | 80        | 80        | 100       |
| Sp mm       | 2         | 2         | 2         | 2         | 2         | 2         | 2         | 2         |
| CODICE ART. | 125008040 | 125001040 | 125001240 | 125001260 | 125001660 | 125001680 | 125002080 | 125002010 |
| N° Pcs      | 50        | 50        | 50        | 50        | 50        | 25        | 25        | 25        |
| Kg.         | 2,130     | 2,960     | 3,135     | 5,450     | 6,990     | 4,850     | 5,940     | 7,550     |

### Piastra piana

Connecteur plat  
Flat connector  
Connexion plana

### Art. 12501

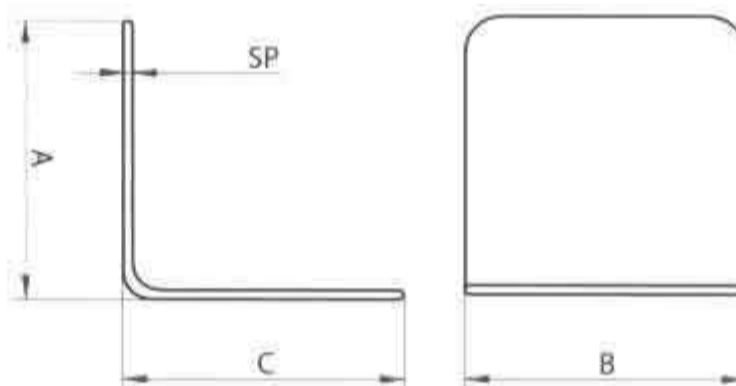

In acciaio tropicalizzato  
Acier bichromaté  
Steel yellow galvanized  
Hierro bicromatado

| A mm        | 40       | 60       | 60       | 80       | 80       | 80       | 100      | 100      | 120      |
|-------------|----------|----------|----------|----------|----------|----------|----------|----------|----------|
| B mm        | 40       | 40       | 60       | 40       | 60       | 80       | 80       | 100      | 100      |
| C mm        | 40       | 60       | 60       | 80       | 80       | 80       | 100      | 100      | 120      |
| Sp mm       | 2        | 2        | 2        | 2        | 2        | 2        | 2        | 2        | 2        |
| CODICE ART. | 12514040 | 12516040 | 12516060 | 12518040 | 12518060 | 12518080 | 12511080 | 12511010 | 12511210 |
| N° Pcs      | 50       | 50       | 50       | 50       | 50       | 25       | 25       | 25       | 25       |
| Kg.         | 2,000    | 3,250    | 4,380    | 5,190    | 6,970    | 4,730    | 6,000    | 7,750    | 8,830    |

### Piastra piegata

Connecteur 90°  
Connector 90°  
Connexion 90°

### Art. 12504

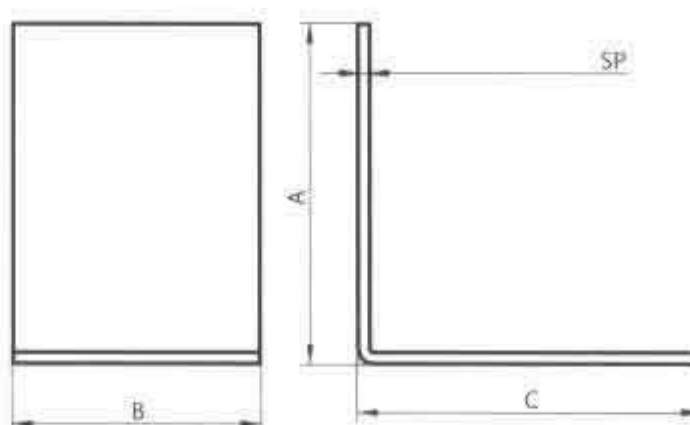

In acciaio tropicalizzato  
Acier bichromaté  
Steel yellow galvanized  
Hierro bicromatado

| A mm        | 50        | 90        |
|-------------|-----------|-----------|
| B mm        | 40        | 40        |
| C mm        | 50        | 90        |
| Sp mm       | 2         | 2         |
| CODICE ART. | 125045040 | 125044040 |
| N° Pcs      | 50        | 50        |
| Kg.         | 2,420     | 5,250     |

Connecteur 90°  
Connector 90°  
Connexion 90°

### Piastra piegata per giunzione



**Art. 12506**



In acciaio tropicalizzato  
Acier bichromaté  
Steel yellow galvanized  
Hierro bicromatado

|               |           |           |           |
|---------------|-----------|-----------|-----------|
| <b>A mm</b>   | 40        | 40        | 40        |
| <b>B mm</b>   | 80        | 140       | 180       |
| <b>C mm</b>   | 40        | 40        | 40        |
| <b>Sp mm</b>  | 2         | 2         | 2         |
| CODICE ART.   | 125064080 | 125064040 | 125064018 |
| <b>N° Pcs</b> | 50        | 50        | 50        |
| <b>Kg.</b>    | 3,000     | 5,050     | 5,280     |

**Piastra a "L" per giunzione**

Connecteur 90°  
Connector 90°  
Connexion 90°

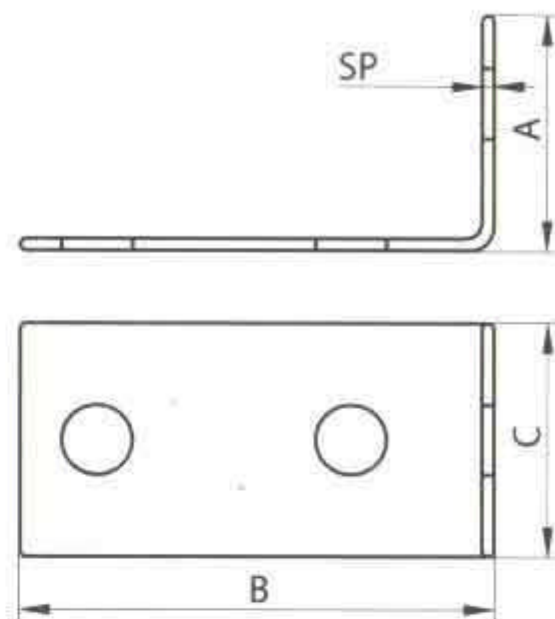

**Art. 12510**

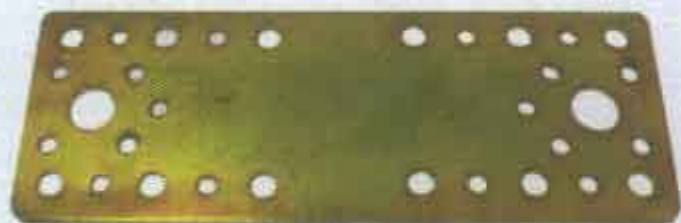

In acciaio tropicalizzato  
Acier bichromaté  
Steel yellow galvanized  
Hierro bicromatado

|               |           |           |
|---------------|-----------|-----------|
| <b>A mm</b>   | 180       | 200       |
| <b>B mm</b>   | 65        | 90        |
| <b>Sp mm</b>  | 2,5       | 3         |
| CODICE ART.   | 125101865 | 125102090 |
| <b>N° Pcs</b> | 25        | 25        |
| <b>Kg.</b>    | 4,730     | 9,500     |

**Piastra piana per giunzione**

Connecteur plat  
Flat connector  
Connexion plana

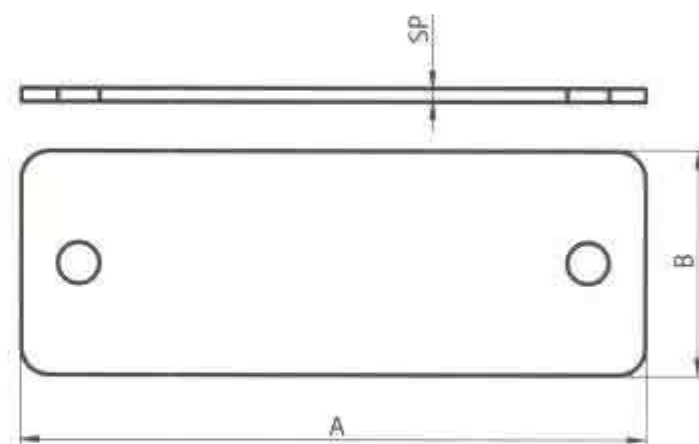

**Art. 12511**



In acciaio tropicalizzato  
Acier bichromaté  
Steel yellow galvanized  
Hierro bicromatado

|               |           |           |
|---------------|-----------|-----------|
| <b>A mm</b>   | 90        | 100       |
| <b>B mm</b>   | 65        | 90        |
| <b>C mm</b>   | 90        | 100       |
| <b>Sp mm</b>  | 2,5       | 3         |
| CODICE ART.   | 125119065 | 125111090 |
| <b>N° Pcs</b> | 25        | 25        |
| <b>Kg.</b>    | 4,730     | 9,500     |

**Piastra ad angolo per giunzione**

Connecteur 90°  
Connector 90°  
Connexion 90°

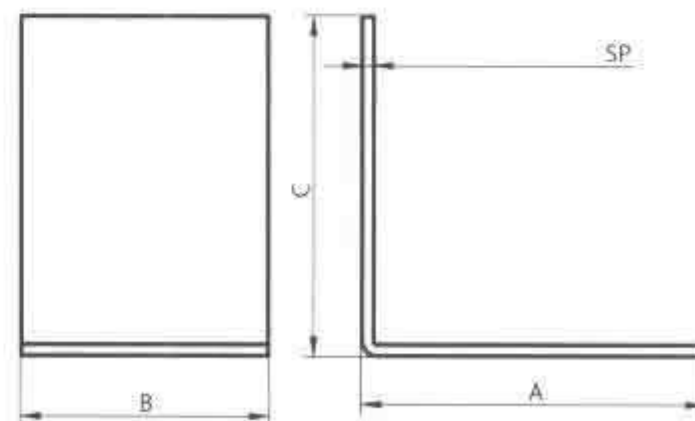

### Piastra ad angolo nervata per giunzione

Art. 12512

Connecteur 90°  
Connector 90°  
Connexion 90°



In acciaio tropicalizzato  
Acier bichromaté  
Steel yellow galvanized  
Hierro bicromatado

|               |           |           |
|---------------|-----------|-----------|
| <b>A mm</b>   | 90        | 100       |
| <b>B mm</b>   | 65        | 90        |
| <b>C mm</b>   | 90        | 100       |
| <b>Sp mm</b>  | 2,5       | 3         |
| CODICE ART.   | 125129065 | 125121090 |
| <b>N° Pcs</b> | 25        | 25        |
| <b>Kg.</b>    | 4,730     | 9,500     |

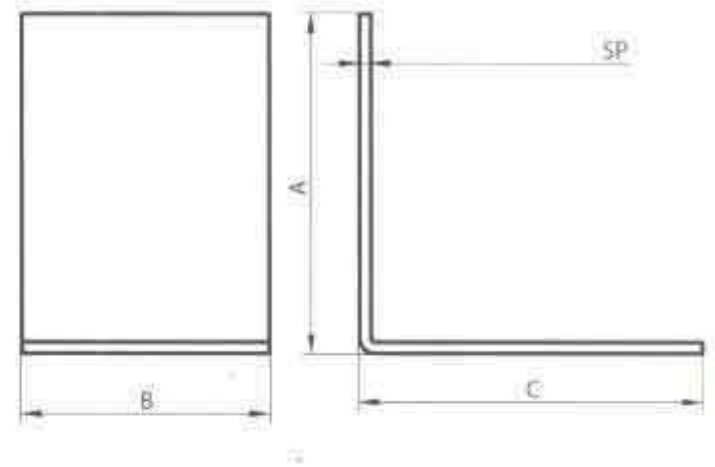

### Piastra piegata per giunzione - angolo 135°

Art. 12513

Connecteur 135°  
Connector 135°  
Connexion 135°



In acciaio tropicalizzato  
Acier bichromaté  
Steel yellow galvanized  
Hierro bicromatado

|               |           |           |
|---------------|-----------|-----------|
| <b>A mm</b>   | 90        | 100       |
| <b>B mm</b>   | 65        | 90        |
| <b>C mm</b>   |           |           |
| <b>Sp mm</b>  | 2,5       | 3         |
| CODICE ART.   | 125139065 | 125131090 |
| <b>N° Pcs</b> | 25        | 25        |
| <b>Kg.</b>    | 4,730     | 9,500     |

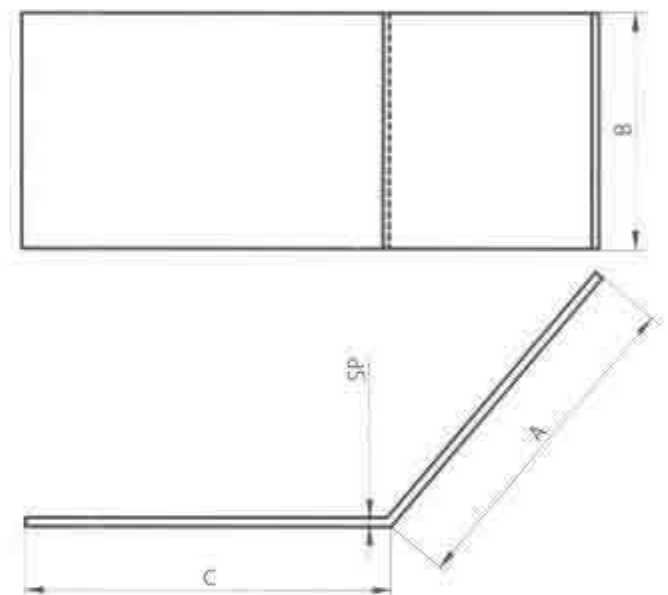

### Supporto per travi con ali

Art. 12519

Support de poutre  
Support for beam  
Soporte de palo



In acciaio tropicalizzato  
Acier bichromaté  
Steel yellow galvanized  
Hierro bicromatado

|               |           |           |           |
|---------------|-----------|-----------|-----------|
| <b>A mm</b>   | 80        | 100       | 120       |
| <b>B mm</b>   | 75        | 75        | 75        |
| <b>Sp mm</b>  | 2         | 2         | 2         |
| CODICE ART.   | 125198075 | 125191075 | 125191275 |
| <b>N° Pcs</b> | 25        | 25        | 25        |
| <b>Kg.</b>    | 7,620     | 9,000     | 10,660    |

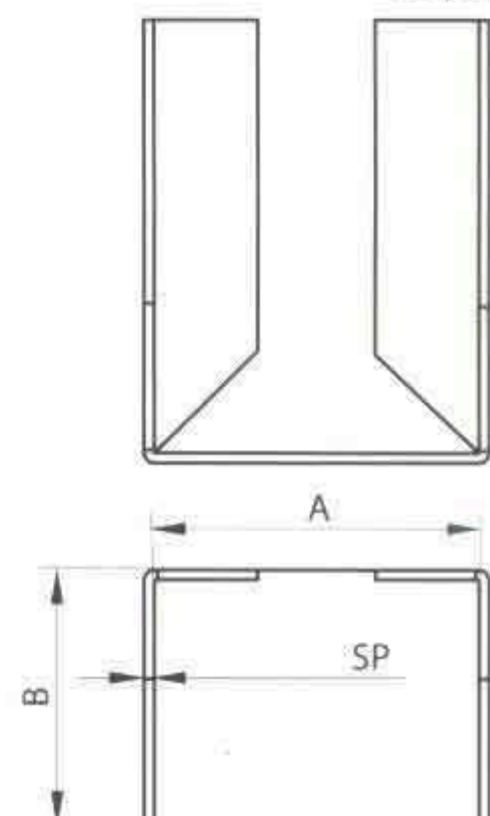

**Art. 12520**



In acciaio tropicalizzato  
Acier bichromaté  
Steel yellow galvanized  
Hierro bicromatado

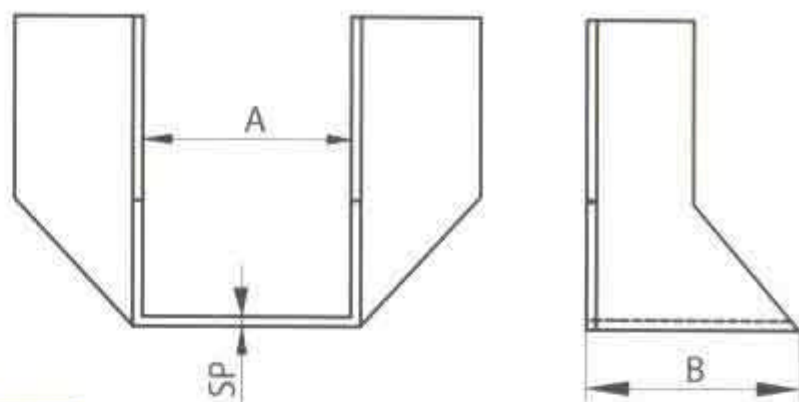

**Supporto per travi**

Support de poutre  
Support for beam  
Soporte de palo

| A mm        | 80        | 100       | 120       |
|-------------|-----------|-----------|-----------|
| B mm        | 75        | 75        | 75        |
| Sp mm       | 2         | 2         | 2         |
| CODICE ART. | 125208075 | 125201075 | 125201275 |
| N° Pcs      | 25        | 25        | 25        |
| Kg.         | 7,620     | 9,000     | 10,660    |

**Art. 12521**

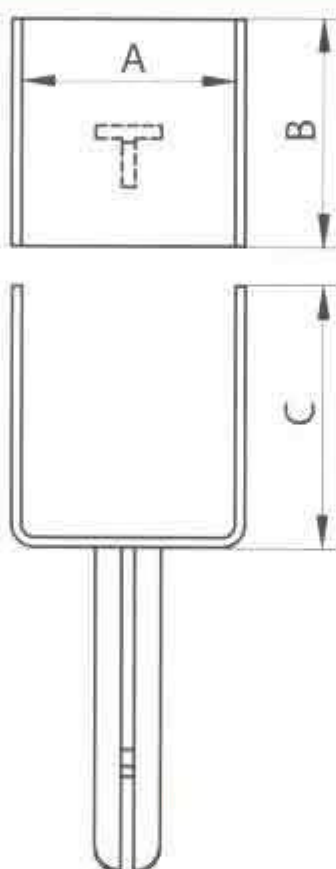

**Supporto a "U" per pali**

Support de poutre a "U"  
Pole support  
Soporte de palo

In acciaio tropicalizzato  
Acier bichromaté  
Steel yellow galvanized  
Hierro bicromatado

| A mm        | 71      | 81      | 91      | 101      | 121      |
|-------------|---------|---------|---------|----------|----------|
| B mm        | 70      | 70      | 70      | 70       | 70       |
| C mm        | 123     | 118     | 113     | 108      | 98       |
| Sp mm       | 3       | 3       | 3       | 3        | 3        |
| CODICE ART. | 1252171 | 1252181 | 1252191 | 12521101 | 12521121 |
| N° Pcs      | 10      | 10      | 10      | 10       | 10       |
| Kg.         | 7,550   | 7,550   | 7,550   | 7,550    | 7,550    |

**Art. 12522**



In acciaio tropicalizzato  
Acier bichromaté  
Steel yellow galvanized  
Hierro bicromatado

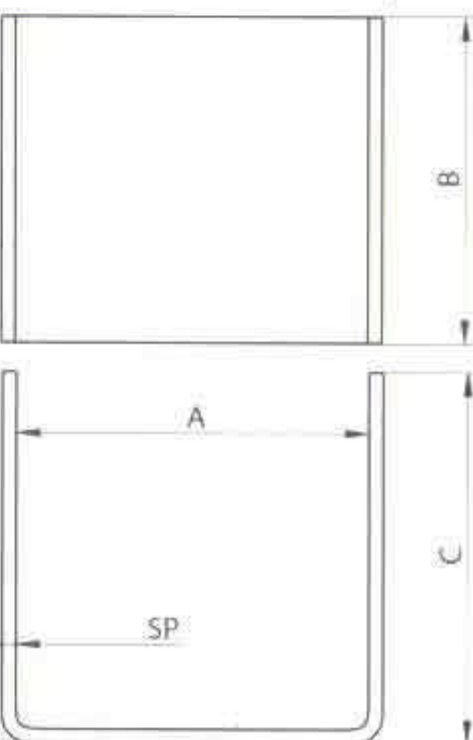

Support de poutre  
Pole support  
Soporte de palo

| A mm        | 81      | 91      | 101      |
|-------------|---------|---------|----------|
| B mm        | 70      | 70      | 70       |
| C mm        | 118     | 113     | 108      |
| D mm        | 25      | 25      | 25       |
| Sp mm       | 3       | 3       | 3        |
| CODICE ART. | 1252281 | 1252291 | 12522101 |
| N° Pcs      | 12      | 12      | 12       |
| Kg.         | 8,640   | 8,860   | 8,920    |



LEGNO - BOIS  
WOOD - MADERA

**Art. 12523**

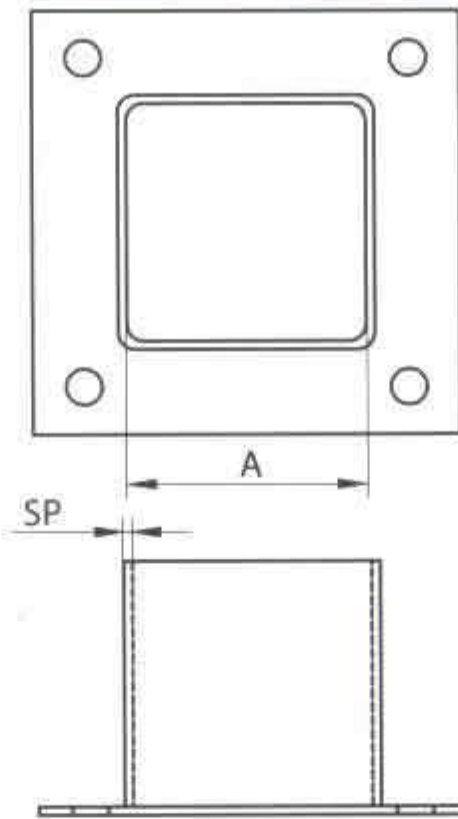
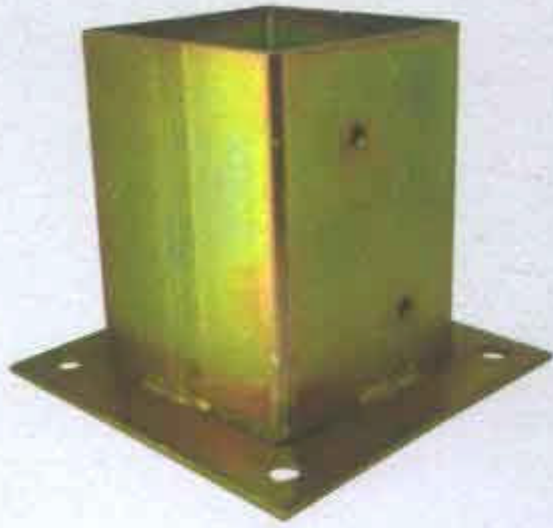

**Supporto d'appoggio per pali**

Support pour pilier  
Support for poles  
Soporte de palo

In acciaio tropicalizzato  
Acier bichromaté  
Steel yellow galvanized  
Hierro bicromatado

|               |         |         |
|---------------|---------|---------|
| <b>A mm</b>   | 70      | 90      |
| <b>Sp mm</b>  | 3       | 3       |
| CODICE ART.   | 1252370 | 1252390 |
| <b>N° Pcs</b> | 10      | 10      |
| <b>Kg.</b>    | 15,230  | 18,300  |

**Art. 12524**



In acciaio tropicalizzato  
Acier bichromaté  
Steel yellow galvanized  
Hierro bicromatado

|               |           |           |
|---------------|-----------|-----------|
| <b>A mm</b>   | 71        | 91        |
| <b>B mm</b>   | 170       | 210       |
| <b>C mm</b>   | 45        | 45        |
| <b>Sp mm</b>  | 4         | 4         |
| CODICE ART.   | 125247117 | 125241721 |
| <b>N° Pcs</b> | 10        | 10        |
| <b>Kg.</b>    | 7,400     | 7,930     |

**Supporto d'avvitare per pali**

Support pour pilier  
Support for poles  
Soporte de palo

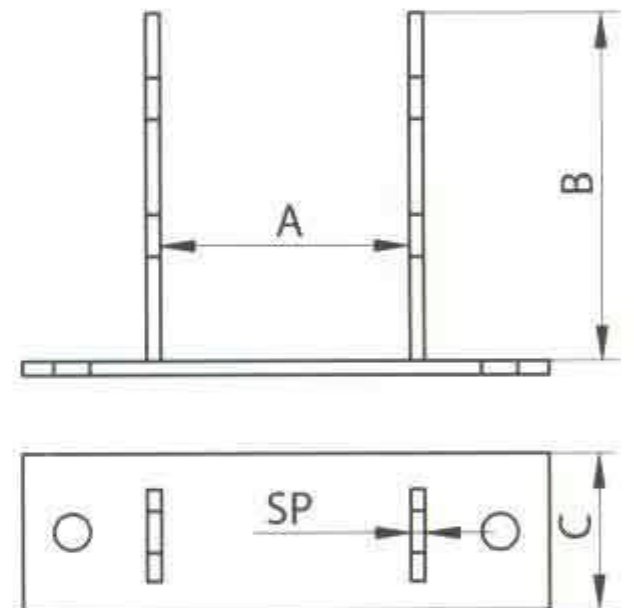

**Art. 9770**



Completa di n° 4 chiavi  
Complet avec 4 clés  
Completo with 4 key  
Con 4 llaves

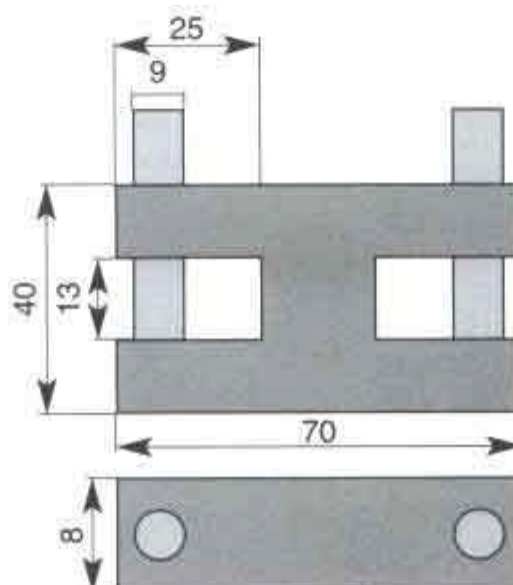

**Lucchetto per catena**

Cadenas pour chaine  
Padlock for chain  
Cerradura para cadena

Corpo ottone cromato  
con aste in acciaio temprato.

Material laiton chromé avec  
tiges en acier trempé.

Chromed brass body  
with rods in hardened steel.

Laiton cromado  
con palitos en acero templado.

|   |                   |   |
|---|-------------------|---|
| <b>Confezioni<br/>Emballage<br/>Packing</b> | <b>N°<br/>Pcs</b> | 6 |
|   | <b>Kg</b>         |   |

